

2012

# An evaluation of whether artificial refuge traps or baited traps are the most effective method for trapping White-clawed crayfish (*Austropotamobius pallipes*)

Walter, K.

Walter, K. (2012) 'An evaluation of whether artificial refuge traps or baited traps are the most effective method for trapping White-clawed crayfish (*Austropotamobius pallipes*)', *The Plymouth Student Scientist*, 5(2), p. 443-485.

<http://hdl.handle.net/10026.1/13997>

---

The Plymouth Student Scientist  
University of Plymouth

---

*All content in PEARL is protected by copyright law. Author manuscripts are made available in accordance with publisher policies. Please cite only the published version using the details provided on the item record or document. In the absence of an open licence (e.g. Creative Commons), permissions for further reuse of content should be sought from the publisher or author.*

# **An evaluation of whether artificial refuge traps or baited traps are the most effective method for trapping White-clawed crayfish (*Austropotamobius pallipes*) in the Creedy Yeo River, Devon.**

Kathryn Walter

Project Advisor: [Paul Lunt](#), School of Geography, Earth and Environmental Sciences  
Plymouth University, Drake Circus, Plymouth, PL4 8AA

## **Abstract**

Britain's only native crayfish species, the white-clawed crayfish *Austropotamobius pallipes* are threaten through rapid population declines caused by non-indigenous species, habitat degradation and pollution. This study focuses one of the last remaining small *A. pallipes* population in the Creedy Yeo River, Devon. This study aims to decipher whether the use of artificial refuge traps (ARTs) or baited traps are the most effective method of catching this species, to aid translocation efforts to conserve the remaining population under threat from the American signal crayfish *Pacifastacus leniusculus*. The capture rate of each type of trap was studied at four sites along the river, along with the size and gender of crayfish caught and a survey of the habitat conditions. The ARTs were already in place along the river and baited traps were installed the day before a translocation, using fresh sardines as bait. The results showed that ARTs caught more crayfish of a lower size in comparison to the baited traps which caught large adult crayfish. There was no significant difference in the capture rate of either trap type and no relationship was found between habitat variables of shade cover, siltation level and main refuge types in the riverbank or channel. To conclude, this study suggests that there are a wide multitude of factors determining condition that can influence the capture rate of crayfish. The most consistent capture method was using the ARTs, as baited traps were unreliable in low density populations. This can be applied to aid conservation methods in other low density river populations.

## 1.0 Introduction

In the freshwater ecosystem crayfish are seen as a keystone species of a healthy environment, as well as being the largest and most mobile invertebrate (Holdich, 2003). Research has shown that the introduction or eradication of this species can have an impact on other aquatic biota (National Rivers Authority, 1995).

The threat of population decline faces an estimated one-third to one-half of the world's crayfish populations (Taylor, 2002). This has been caused by numerous threats, especially the introduction of non-native species, whether intentional or accidental, which have lasting damaging effects on an ecosystem. Non-indigenous crayfish species (NICS) outnumber indigenous crayfish species (ICS) by 2:1, the NICS are predicted to dominate watercourses if no actions are taken to preserve the native species (Holdich *et al.*, 2009). This is the case throughout Europe in which many countries maintain at least one ICS, but all of these are under huge threat from decreasing water quality, habitat loss, over fishing, climate change and crayfish plague carried by NICS (Holdich *et al.*, 2009).

The UK only has one native crayfish known as the white-clawed crayfish *Austropotamobius pallipes* (Plate 1), which is threatened by the non-indigenous American Signal crayfish *Pacifastacus leniusculus*. The native *A. pallipes* gains its name from the contrast of the pale underside of the claws in comparison to the rest of its body (Devon BAP, 2009). The populations of white-clawed crayfish are rapidly declining which is why conservation efforts are paramount in protecting this species.



Plate 1. A White-clawed crayfish *A. pallipes*, which is distinguished by a pink-white underside and barbs located behind their eyes on its carapace (Holdich, 2003).

## 1.1 Life History

The breeding season for white-clawed crayfish takes place from autumn to early winter (September to November). The process is triggered by a change in day length and the temperature dropping below 10°C for a long period of time (Holdich, 2003). The eggs are held under the females' tail over winter. A female in this condition is known to be 'berried' (Plate 2). The number of eggs can vary from 20 to 160 but less than a 100 eggs is more common (Holdich, 2003).



Plate 2. A female *A. pallipes* with eggs attached to the underside of her tail. This condition is known as 'berried' (Holdich 2003).

The eggs hatch on the female from late spring to early summer and the juveniles go through moulting until they reach the second stage of development, where they become independent. This process takes between two to three weeks (Devon BAP, 2009), during which juveniles are most prone to predation (National Rivers Authority, 1995).

Crayfish reach sexual maturity after three to four years and can live for more than ten years, with a varied size range in a population demonstrating a breeding population (Holdich, 2003). The average size of the total length, ranging from the rostrum (snout) to the telson (tail plate) of the crayfish is less than 10 cm. Crayfish are mainly active at night and take refuge during the day (Devon BAP, 2009).

## 1.2 Habitat Preferences

The white-clawed crayfish can be found in a variety of habitats such as rivers, lakes and water-filled quarries. This report focuses on crayfish found in rivers, research has shown that crayfish can be found in shallow streams (5 cm) to slow flowing deeper rivers (Holdich, 2003). This species of crayfish prefers cryptic habitats such as under rocks, tree roots and submerged logs as its refuge and will emerge to forage for food (Holdich, 2003). When occupying flowing water such as a river, *A. pallipes* has been recorded in overhanging river banks with juveniles being discovered under cobbles or boulders, amongst root systems of woody vegetation and boulder weirs (Holdich, 2003). The ideal habitat types are summarised in Table 1.

In addition to ideal refuge habitat, there must be a reliable food supply. *A. pallipes* are omnivores, with their main diet consisting of insect larvae, worms, small fish, snails, algae and macrophytes (Holdich, 2003). The moulting process requires calcified plants to be an important component of the diet, which speeds up the hardening process of the outer shell.

**Table 1.** A summary of ideal habitats which crayfish prefer separated by magnitude of preference (adapted from Peay, 2003).

| Habitat which crayfish strongly prefer                                                                                                                                      | Habitat types that crayfish may use                                          | Habitat type that crayfish would not prefer or may avoid               |
|-----------------------------------------------------------------------------------------------------------------------------------------------------------------------------|------------------------------------------------------------------------------|------------------------------------------------------------------------|
| Boulders (> 25cm), stone or other material                                                                                                                                  | Large cobbles (15 cm – 25 cm)                                                | Small cobbles (6 cm – 15 cm)                                           |
| Slow-flowing glides and pools (provided there are refuges)                                                                                                                  | Riffles                                                                      | High energy areas such as rapids (avoided)                             |
| Localised velocity of 0.1 m s <sup>-1</sup> or less                                                                                                                         | Less than 0.2 m sec <sup>-1</sup>                                            | More than 0.2 m sec <sup>-1</sup> (avoided)                            |
| Boulders or large cobbles in groups with crevices between them                                                                                                              | Isolated large stones on smaller substrate such as pebble and gravel         | A lot of small stone (small cobbles and pebble)                        |
| Deep crevices in bedrock                                                                                                                                                    | Partly flattened boulders and large cobbles                                  | High-sided, rounded cobbles (more easily rolled in spates)             |
| Underlying substrate of fine gravel/sand with some pebbles                                                                                                                  | Pebble and coarse gravel                                                     | Clay                                                                   |
| Loose boulders                                                                                                                                                              | N/A                                                                          | Deeply bedded boulders in a compacted bed (not accessible to crayfish) |
| Submerged refuges in stable banks (e.g. natural crevices, stone block reinforcement or stable, slightly undercut banks with overhanging vegetation, large tree roots, etc.) | Refuges in the slow-flowing margins                                          | Refuges in mid-channel (especially if flow is a run or higher energy)  |
| Margins next to favourable bankside habitat                                                                                                                                 | Margins where adjacent banks have no scope for refuges (e.g. shallow slopes) | Margins where adjacent earth banks are slumped and actively eroding    |

### 1.3 Threats

There are numerous threats to *A. pallipes* including competition from non-indigenous species, disease, predators and pollution. The amalgamation of these factors has led to rapid decline of the species.

*A. pallipes* are threatened by the invasive American Signal Crayfish *Pacifastacus leniusculus*, which compete and predate on the native species (Plate 3). This alien species was introduced to the UK in 1976 to provide as an additional food source to the native crayfish. However, they managed to escape from enclosures and invaded surrounding water bodies, where they began to out-compete the native crayfish (Varia, 2010). There is no effective method of controlling the spread of *P. leniusculus* resulting in their impact causing a huge problem (Devon Wildlife Trust, 2004).



Plate 3. American Signal Crayfish *Pacifastacus leniusculus*, (WildaboutBritain, 2006).

This species carry the fungal disease *Aphanomyces astaci*, commonly known as crayfish plague, which has little impact on them but the native *A. pallipes* are highly susceptible (Peay, 2006). It has the capability to wipe out an entire native crayfish population as the spores are viable for up to two weeks. Once a crayfish catches the disease, it releases millions of spores into the water resulting in an almost certain epidemic (Peay, 2006). However, the presence of American species does not automatically mean there will be a plague epidemic.

*A. pallipes* suffer from another disease known as porcelain disease caused by the protozoan *Thelohania contejeani* (Devon BAP, 2009). This disease causes less mortality in comparison to crayfish plague and can be present in 10% of the population without causing a high detrimental impact (Holdich, 2003). The visible symptoms of this disease consist of white colouration of the body tissues (most noticeable in the tail) when the crayfish are observed from underneath.

Further threats include predation from a range of species, including fish such as eel, trout and pike, as well as mammals (rats and otters) and birds (heron and crows) (Holdich, 2003). Additionally, crayfish are highly susceptible to pollution incidents with the introduction of biocides having the potential to cause mass mortalities. Crayfish have a low tolerance to high levels of ammonia and a slightly higher tolerance to low dissolved oxygen levels, as they have the capacity to climb into air if necessary (Peay, 2009).

#### 1.4 Legislation

*A. pallipes* are listed on the IUCN Red Data List for endangered and threatened species and scheduled under the Wildlife and Countryside Act 1981 under the EC Habitat Directive which makes the removal or selling of *A. pallipes* illegal (Peay, 2000). Section 9 of this Act gives further protection to this species as it has made it a criminal offence to deliberately or recklessly kill or injure *A. pallipes*. This species is prone to inhabiting any structures in a waterway which have a poor structure as they exploit the crevices for refuge, resulting in maintenance works having high potential of harming *A. pallipes* which is illegal (Peay, 2000). Natural England monitors the conservation efforts of this species as they can issue licences for translocation operations where maintenance could risk killing or injuring this species (Peay, 2000). Further protection is offered under the Bern Convention under Appendix 3, which monitors the exploitation of any species under this appendix (JNCC, 2012). The UK

Biodiversity Action Plan (BAP) ensures a national action plan is in place and overseen by key organisations (Peay, 2000).

The Wildlife and Countryside Act 1981 protects this species from sale and being taken from the wild, although it does not provide protection for the habitat occupied by crayfish. In order to remove white-clawed crayfish for scientific research or education, a licence is required from Natural England, Scottish Natural Heritage or Countryside Council for Wales, depending on the location (National Rivers Authority, 1995). Furthermore, since 1992, Section 14 of this act states that it is an offence to release any non-native crayfish into the wild (Scott, 2000). These legislative measures provide a network of protection for *A. pallipes*, although it is not without flaws as it is extremely difficult to prove that the species have been released unless the act was witnessed, making the Wildlife and Countryside Act difficult to enforce (Scott, 2000). While extensive protective legislation exists, it is not without its issues.

### 1.5 Distribution

This species is widespread throughout mainland Europe (Fig 1.4). However, these populations have become more sporadic and are in serious decline due to waterway modification schemes, pollution and crayfish plague (NRA, 1995).

The current situation of white-clawed crayfish in Britain is very serious. Records show that since the 1970s there has been a 95% reduction in Hampshire, more than 95% loss was documented by the Thames Environment Agency (Ellis, 2009) and a 100% loss in East and West Sussex (Holdich *et al.*, 2009). Their distribution depends mainly on water quality and geology throughout the British Isles, with preference towards comparatively hard mineral-rich water with a pH range of 6.5 – 9.0 and a minimum calcium level of 5mg L<sup>-1</sup> (Devon BAP, 2009). Sibley (2004) has predicted that *A. pallipes* will be lost nationally in the next 30 – 40 years. The highest concentration of *A. pallipes* populations are in central and northern England as crayfish plague wiped out many populations that were situated elsewhere. It does not occur naturally in Scotland or western Wales (Devon BAP, 2009).



Figure 1. The distribution of *A. pallipes* throughout Europe is shown in green (Holdich, 2003).

### 1.6 Conservation in South-West England

In South-West England, the populations of *A. pallipes* have reached critical levels; between 1990 and 1996 there was a 28% reduction in their distribution by 10km squares and a 71% increase in non-indigenous crayfish species such as *P. leniusculus* (Holdich *et al.*, 2009). The impacts of these species are demonstrated in Fig 2.

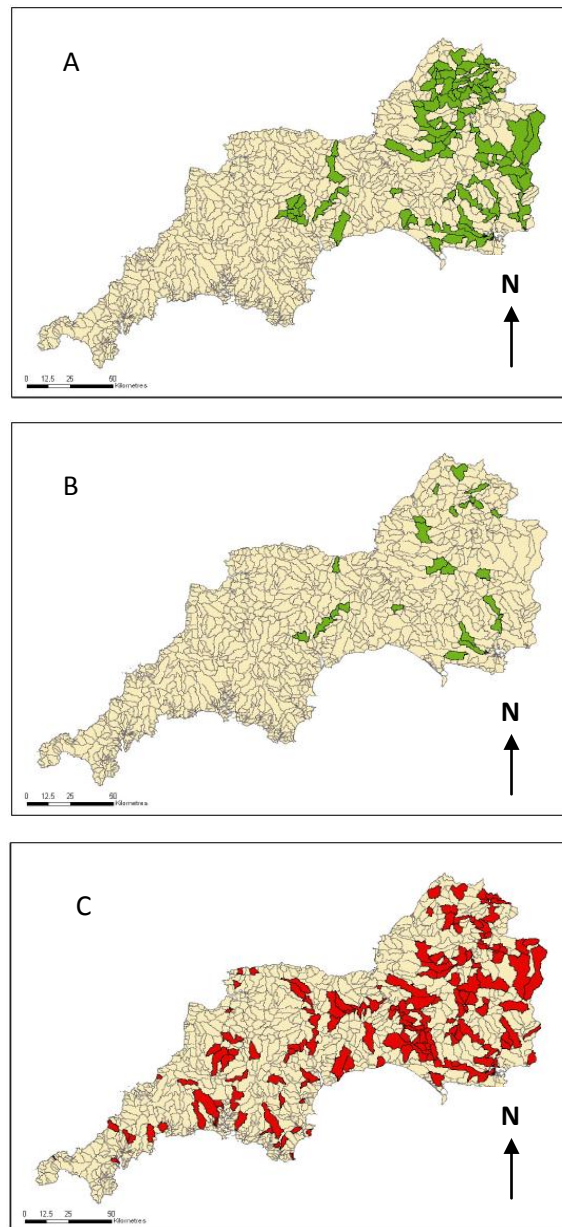

Figure 2. A three stage representative of the impacts of non-indigenous crayfish in the South-West of England. Part A shows the estimated *A. pallipes* population in 1975. Part B depicts the *A. pallipes* population estimate in 2009 and part C shows the population of non-native crayfish in 2009 (Holdich et al., 2009).

It is clear to see the detrimental impact of years of non-native crayfish colonising the waterways in the South-West. The American Signal Crayfish, *P. leniusculus* is the most widespread (Holdich et al., 2009). The spread of non-indigenous crayfish is serious and has arrived at the cost of many *A. pallipes* populations. Furthermore the non-indigenous crayfish have inhabited water which was unsuitable for *A. pallipes*.

In response to these declining populations, the South-West Crayfish Project was developed which works on protecting the few remaining populations of *A. pallipes*. The project is an amalgamation of a variety of steering groups including Bristol Zoo



Gardens, Avon Wildlife Trust and the Environment Agency (EA) as well as numerous contacts and partners (South-West Crayfish Conservation Strategy, 2008). They have a variety of aims; such as driving UK BAP targets and contributing to European Union conservation targets, identifying and prioritising the most threatened wild populations of *A. pallipes* and running an educational programme to expand knowledge and understanding to the public on key issues. Also, important successful factors which aid translocations, introductions and captive breeding plans will be documented and reported to stakeholders (South-West Crayfish Conservation Strategy, 2008).

Conservation efforts which have gone into carrying out translocations from river systems to ark sites have resulted in these sites containing over one fifth of the remaining *A. pallipes* population in the South-West (Holdich *et al.*, 2009). An ark site is a habitat where indigenous crayfish species are isolated from the threat of alien species. This is achieved by locating a secluded area of still or running water that can support a population with little management to be continued (Holdich *et al.*, 2009). The purpose of these sites is to act as holding areas for breeding *A. pallipes* populations, whilst efforts in controlling *P. leniusculus* are established. The final aim is to be in a position where *A. pallipes* can be reintroduced to river systems after the removal of the invasive *P. leniusculus*.

### 1.7 Present status in Devon

There are not many rivers which are suitable for *A. pallipes* in Devon due to the rivers being mostly acidic (Devon BAP, 2009). There are two known populations, one of which is situated sparsely over a 15 km stretch of the Creedy Yeo River in the sub-catchment of the Exe, and the second was discovered in 2007 in the River Culm (Devon BAP, 2009). The two remaining populations were recorded at extremely low densities. In 2003 American signal crayfish *P. leniusculus* were recorded in a tributary to the Creedy Yeo River and their progress has been monitored by the EA since (Crayfish Project Proforma, 2010). This places the remaining native *A. pallipes* populations at risk from competition, predation and disease from the non-indigenous species (Devon BAP, 2009).

Surveys between 2003 and 2004 identified the population in the Creedy Yeo River as a healthy breeding population by recording the size of their carapace. The results demonstrated an age range of one to seven years old (Lowery, 1988). The Devon Biodiversity Action Plan (BAP) notes that the smaller size range could be influenced by environmental conditions of the river or perhaps linked to a sewage treatment works failure that occurred, which did not appear to vastly damage the population (Crayfish Project Proforma, 2010).

An action plan has been developed by the EA to address all of the measures needed to protect the native *A. pallipes* from threats thus aiding their survival. This population has been identified as the potential source for an ark site and surveys have been continually carried out in a bid to translocate as many individuals as possible before the population become extinct (Crayfish Project Proforma, 2010). The EA have been using artificial refuge traps (ARTs) to catch the remaining *A. pallipes* populations which have not yet been infiltrated by *P. leniusculus*. To carry out translocations there are a variety of survey methods and trapping techniques.

## 1.8 Trapping techniques

The different types of survey methods used to catch crayfish each have their own limitations. There is no standardised method as it is subjective on the river type. This studying focuses on using two types of traps; ARTs and baited traps to trap crayfish for translocation.

### 1.8.1 Artificial refuge traps (ARTs)

The ARTs were originally designed by Hampshire and Avon EA team (Green, 2009). Through experience of using these ARTs, their design was amended by Nicky Green, an associate of the South-West Crayfish Project, to replace the smallest width pipe with a larger width pipe, to attract any invasive *P. leniusculus* if present (Green, 2009). The amended design has been in use for many years (Fig 3).

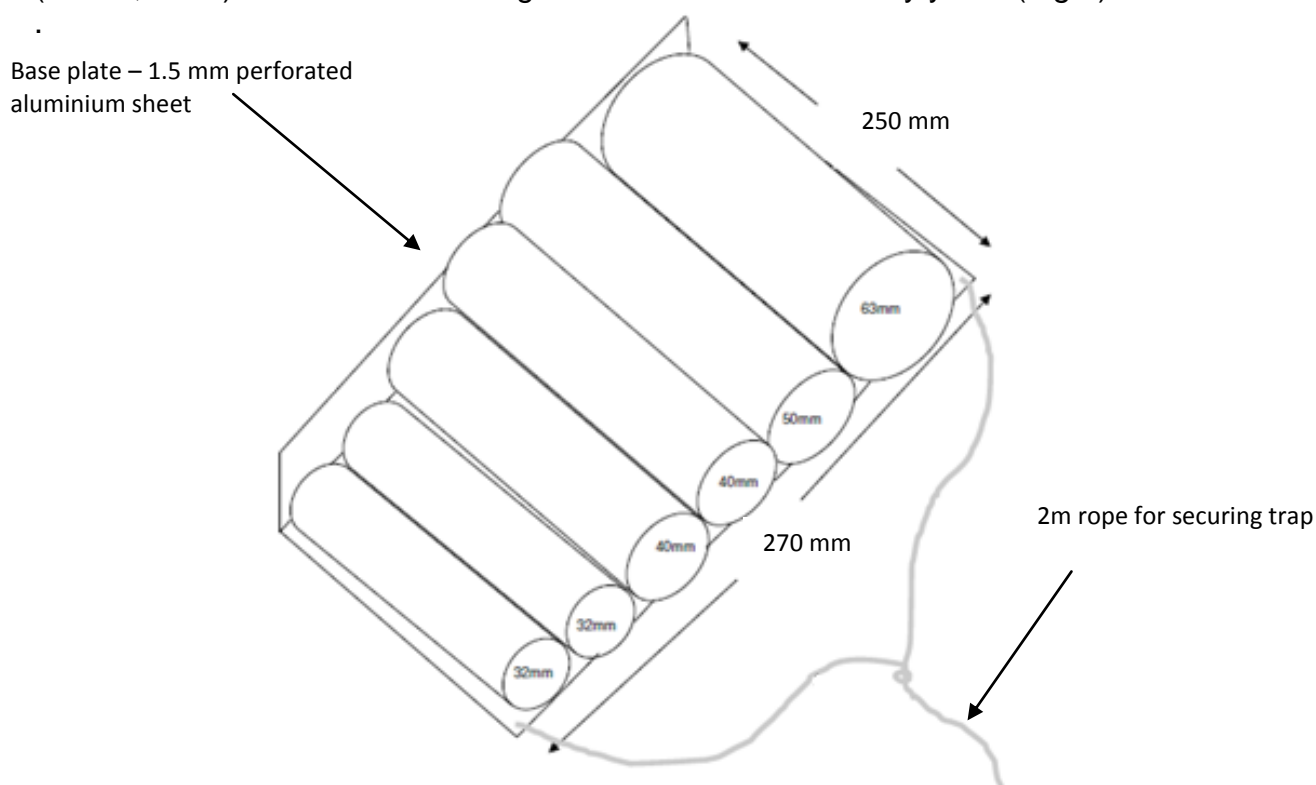

Figure 3. The design of an artificial refuge trap (ART) (not to scale) (Green, 2009).

As the name suggest, these traps mimic crevices by simulating dark, confined conditions which crayfish seeking refuge would be attracted to. The main advantage of these traps is that they do not retain the crayfish, as the ends of the tubes are open, allowing the crayfish to enter and leave (Plate 4). This allows the ARTs to be left in a river for a long period of time as it poses no threat of trapping and starving of crayfish or other fresh water species and reduces the labour intensity of a survey.



Plate 4. An example of an artificial refuge trap (ART) used in rivers.

These ARTs should be positioned at the edge of a watercourse amongst natural refuges, in an area of a river that contains suitable habitat characteristics for crayfish populations. They should be positioned ideally in shaded areas, at 90° to the flow of the waterway to prevent crayfish from either being trapped or washed out by the water flow, or the trap to fill with debris (Green, 2009). The ART should be placed as horizontal as possible with the metal sheet facing skyward to allow stones to be placed on top to secure the trap to the riverbed thus making it more stable (Green, 2009). The open end of the pipes should face towards the river edge. Once the trap is in place, it should be secured by the rope attached, to a stable feature such as a tree to minimise risk of the trap being washed away in high flow circumstances.

For the ARTs to be most effective for *A. pallipes*, they should be used during the survey season which is from July until late of September. To use these traps, the EA must be informed with details of their intended use and the ARTs must be fitted with numbered tags prior to their deployment to enable them to be used to rivers (Green, 2009). A crayfish licence is also required if the traps are intended for conservation purposes.

Research by Green (2009) suggests that the ideal length to assess the presence of a crayfish population is for a period of eight weeks with a minimum check every two weeks. This is not a standardised technique and so it is important to assess sites individually depending on population size.

### 1.8.2 Baited Traps

The alternative option is the baited trap, which retains the crayfish once it has entered the trap. There are numerous sizes and designs for these traps which are controlled by strict guidelines given by the EA to minimise impacts to other freshwater species and those associated with this environment. The entrance(s) of the trap must be no more than 9.5 cm in diameter or in designs where it is over, an

otter guard must be attached to the openings (EA, 2011). The mesh surrounding the trap has a maximum hole diameter of 3 cm and the trap design has a limit of 60 cm in length and 35 cm in width. The baited traps from the EA were used in this study (Plate 5).



Plate 5. The baited trap design used from the Environment Agency, which contain individual numbered tags and are within the standard specifications to cause minimal harm to surrounding wildlife.

These traps are cylindrical in design with two openings at either end of the trap, which is covered in suitable mesh within the guidelines. The entrances consist of funnels directed towards the centre of the trap, the ends of which are pointed making it difficult for the crayfish to find the exit. The bait of choice is placed inside a mesh box that opens at opposite ends and once shut it is then pushed inside the trap.

These traps require a moderate to low flow in a watercourse above 8°C, where they are left overnight when crayfish are most active (Peay, 2003). The benefit of these traps are that they can be used in deep or turbid water as a weight is built into the design allowing them to be deployed from the riverbank, controlled by a length of rope attached to the trap. This minimises the effort needed from surveyors and reduces their risk of working in deep watercourses (Peay, 2003). The general constraints of baited traps is that they are only able to be left in position for a maximum of 24 hours due to the inability of crayfish, or most other species that may wrongly enter the trap. This results in a more labour intensive survey method. Furthermore, baited traps are most successful in high density populations (Peay, 2003). Many variables can influence whether crayfish are attracted to the bait within the trap, resulting in an inconsistent catch per unit.

### 1.9 Justification for research

This study focuses on investigating the most effective trapping methodology for capturing *A. pallipes* from the Creedy Yeo River in Devon. The research was carried out in association with Nicky Green and the EA who are associated with The South-West Crayfish Project. To make conservation efforts as effective as possible it is essential to use the method which will obtain the highest number of crayfish with a

range of ages to translocate a healthy population. A direct comparison of both ARTs and baited traps were carried out as baited traps have been recorded as very successful in other areas of the UK.

### **1.10 Aims and Objectives**

The aim of the study is to identify whether artificial refuge traps (ARTs) or baited traps have the highest capture rate on the *A. pallipes* population in the Creedy Yeo River, Devon.

This will be achieved by looking into the following objectives:

- i) Is there a difference in the capture rate of each type of trap between each site?
- ii) Does the surrounding environmental variables impact the number of crayfish caught in either trap?
- iii) Is there a significant difference between the gender of the crayfish caught in each type of trap?
- iv) Will the presence of baited traps attract more crayfish into the surrounding ARTs?
- v) What is the ideal length of time needed to trap a sufficient proportion of the population of *A. pallipes* in Devon?

This chapter has discussed the relevant legislation, ecology, distribution, background conservation work, trapping techniques and has highlighted the importance of this research in the context of translocation efforts. The next chapter will identify the study area of Crediton, providing a detailed description of the four study sites located along the Creedy Yeo River. Chapter three explains the methodology that was used including experimental design, site preparation, translocation procedure and data analysis. The discussion of these findings is given in chapter four along with limitations of the study and evidence from literature. Final concluding remarks are given in chapter five along with suggestions for further research. This report ends on a detailed reflection of the enterprise placement carried out as part of the ENV302 module.

## **2.0 Site Description**

This research was carried out in the outskirts of Crediton, a town located between Exmoor and Dartmoor in Devon, South-West of the UK (*Fig 4*).

The four experimental sites are positioned in the Downes Estate, along the Creedy Yeo River, on the outskirts of Crediton along the A377 towards Exeter. Translocations of *A. pallipes* were already being carried out at these four sites which are located along the boundary of agricultural land at different sections along this stretch of river (*Fig 5*).

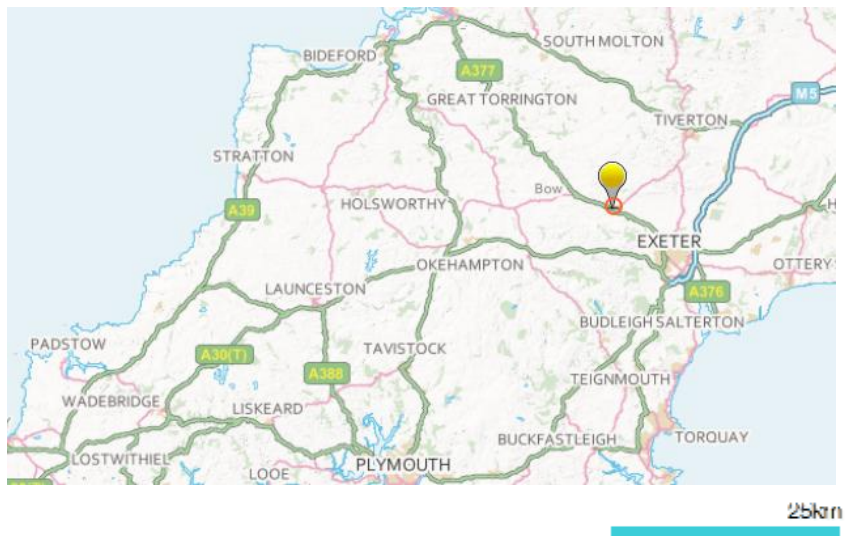

Figure 4. A map depicting the location of Crediton in Devon shown by the marker on the map (Ordnance Survey, 2012).

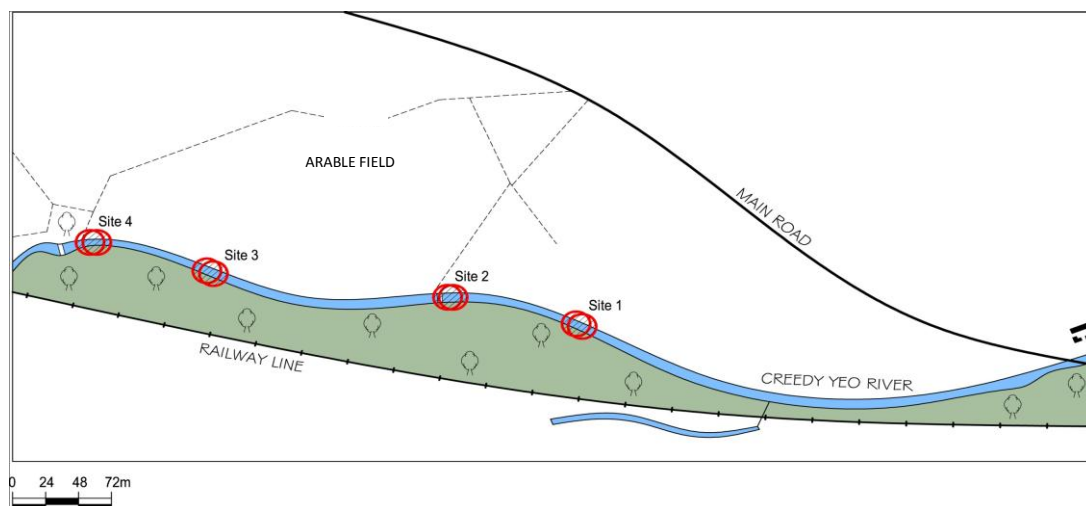

Figure 5. The location of the four experimental sites containing both artificial refuge traps (ARTs) and baited traps along the Creedy Yeo River, Devon.

### 2.1. Study Site 1

This site is the furthest downstream study area which is accessed by a narrow steep path surrounded by Nettles *Urtica dioica* and Himalayan balsam *Impatiens glandulifera* with rotting tree stumps dissecting the path. The left river bank is gently sloping with cobbles becoming more prominent closer to the river edge (Plate 6). All of the crayfish traps are located on the right of the channel which has a steeply sloping bank covered in an extensive root system with a stretch of woodland located on the top. Willow *Salix spp.* and Ash trees *Fraxinus excelsior* extend over the river, casting a 100% shadow over the study area of this site.

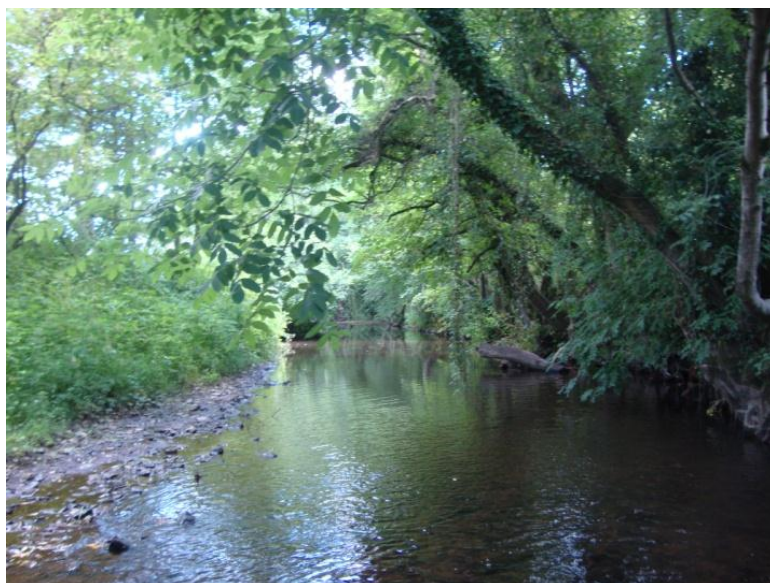

Plate 6. Site 1 looking downstream from the furthest upstream point of the study site.

The water course depth ranges from 0.2m – 0.5m and contains a variety of features which includes mainly marginal dead-water, defined as a section on the river with no discernible flow (Peay, 2003). Additionally there is a run at the furthest upstream point of the study site, where the river surface has a rippled effect with low turbulence (Peay, 2003). The downstream point of Site 1 ends in a pool formation, resulting in deep water with no detectable flow which extends across the middle to the right side of the river bank (Peay, 2003). This site holds a range of refuges for *A. pallipes*, the main refuge type in the river channel consists of cobbles (6.5 – 15cm) amongst larger cobbles, boulders and woody debris. Tree roots on the right side of the river provide the main refuge site in the bank for crayfish. Siltation begins to build from low to moderate in a downstream direction. The main substrate consists of cobbles, gravel and silt.

## 2.2 Study Site 2

The entrance to site 2 is located further upstream, consisting of a steep soil path between the trees down to the river. There is blockwork foundation from the remains of an old footbridge located 5m upstream of the entrance which was undergoing construction to become a new footbridge. This was completed by the end of the study period (Plate 7). The depth of this section of river ranged from 0.1m to 0.4m with shading varying from 50% cover to mainly 100% throughout the study site (Plate 8).



*Plate 7.* The blockwork foundations located upstream of Site 2 entrance that were under construction to provide a footbridge over the river.

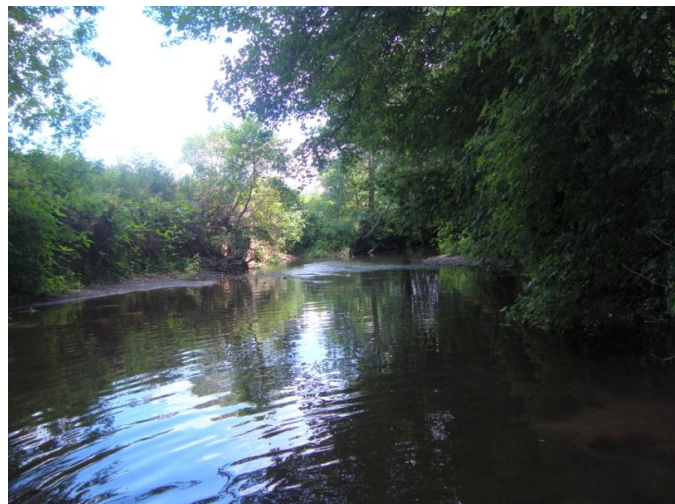

*Plate 8.* The downstream view of Site 2 from the centre of the study site.

In contrast to Site 1, this area contained more boulders which were the dominant refuge types in the river channel, whilst the remaining refuge opportunities consisted of cobbles and tree roots. Additionally, the river banks contain more cobbles as the main refuge opportunity for crayfish. The blockwork foundations of the footbridge dissect the river banks providing a valuable habitat for crayfish. The main substrate of the river comprises of predominantly gravel mixed with pebbles and silt. Moderate siltation occurs throughout the whole study area. The overall evaluation of the whole site rates higher than Site 1 due to the higher concentration of boulders and blockwork bridge providing a wider range of habitats.

### **2.3 Study Site 3**

This area is further upstream with the entrance concealed amongst trees. The depth ranges from 0.1m to 0.4m and has a raised cobble bed upstream (*Plate 9*). The study area covers both upstream and downstream of the raised cobble bed. This section of the river contains mainly marginal deadwater and pools with occasional glides. Glides are defined as a section of the river that has a visual flow but does not break on the surface (Peay, 2003).

This study area is predominantly covered by 100% shade with low to moderate siltation occurring throughout the river (*Plate 10*). The short study area above the raised cobbled bank has a dominant presence of cobbles/boulders in the right river bank, acting as the main refuge type for white-clawed crayfish. This upstream area contains a higher number of boulders in comparison to the downstream section, potentially caused by the raised cobble bed preventing larger stones to move downstream. The main substrate consists of cobbles and pebbles throughout the study area.





Plate 9. The upstream view from the entrance at Site 3, with the study area continuing above the raised cobble bed.



Plate 10. The downstream view from the entrance to Site 3.

#### 2.4 Study Site 4

The final site is accessed through a break in the trees located near the field boundary and leads down the steep left river bank. A weir is located approximately 20m upstream of the site entrance (Plate 11). This results in higher water levels around the weir ranging from 0.3m – 0.4m, with river characteristics including a pool in the right corner of the weir as the water is trapped by a fallen tree, progressing to runs, where the water has low turbulence and a rippled surface (Peay, 2003) and glides moving downstream of the weir.

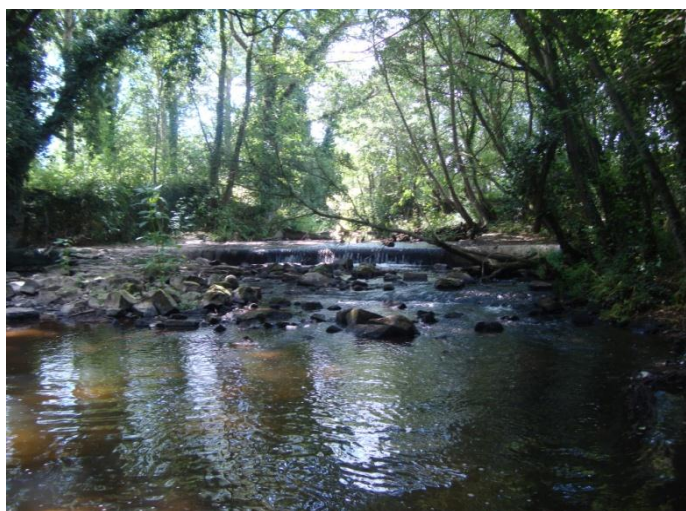

Plate 11. The weir located at the upstream limit of the study area at Site 4.



Plate 12. The view of Site 4 facing upstream towards the weir.

Furthermore, this site has the highest number of boulders present in the river channel combined with a minor presence of cobbles and tree roots. The substrate

comprises mainly of cobbles with some areas containing only gravel. The siltation at this study area is low which could be explained by the faster moving water in comparison to the rest of the sites. The river is widest next to the weir, although the river path narrows when reaching around 15m downstream due to the expanse of cobbles (*Plate 12*).

### 3.0 Methodology

Artificial refuge traps (ARTs) were already in place at the four sites along the Creedy Yeo River, with their individual location recorded. The design of these traps ensures that they can be left in the river for a large length of time as the crayfish have the ability to exit the trap at any time. Therefore the location of the ARTs at each of the study sites remained constant for each visit. The number of ARTs varied at each site with the exact number shown in **Table 2**. The baited traps were installed in groups of six throughout each of the sites.

**Table 2.** The quantity of artificial refuge traps (ARTs) and baited traps at each study site.

| Type of Trap | Study Area |        |        |        |
|--------------|------------|--------|--------|--------|
|              | Site 1     | Site 2 | Site 3 | Site 4 |
| ART          | 9          | 13     | 15     | 10     |
| Baited Trap  | 6          | 6      | 6      | 6      |

The Environment Agency (EA), in partnership with Nicky Green, Devon Wildlife Trust and Buglife were already carrying out translocations from the ARTs located at the four sites. Therefore to assess the impact of baited traps on capture rates, observations were carried out before the baited traps were installed as detailed in the site preparation. Additionally, a habitat survey which was specifically designed for ideal crayfish habitat characteristics was carried out at each site; details of which are explained later in the chapter.

### 3.1 Site Preparation

In total, 24 baited traps were transported to Downes Estate. Upon arrival six of these traps were unloaded and bait was cut and placed within the bait boxes inside the traps (*Plate 13*). The bait consisted of five fresh sardines purchased from the local store on the day which were cut into segments and distributed between the four sites. Researchers were equipped with waders and a record sheet that detailed the location of ARTs and standardised location of baited traps.



Plate 13. The first three stages upon arrival on site. These include transportation of baited traps, offloading six at a time at each site and cutting fresh sardines into five equal segments and placing each segment into the bait box which is then placed within the trap.

Once baited, the six traps were carried to the first site entrance and placed on the river bank, out of reach of the water. The standardised layout of the baited traps involved five traps being placed in between two ARTs and one baited trap was on its own as a control. The ARTs that surrounded these baited traps were checked for crayfish by identifying the rope on the bank and removing the stones which were placed on top of the trap. The trap was lifted vertically by pulling the rope upwards, as the design of the trap allowed it to hang vertically, which prevented any crayfish from falling out. The researchers present on this day did not have a crayfish licence and so were not authorised to handle the crayfish thus a torch was used to look inside the trap to identify if any crayfish were present. On completion, the ART was replaced in the same position as before, with the open end tucked into the river bank and stones placed back on top of the trap to minimise movement. The traps had a unique number on a tag underneath which was checked and used record whether any crayfish were present. Once the surrounding ARTs have been checked, the baited trap was put in place and attached to a secure feature on the river bank (Plate 14).



Plate 14. The next stages before the baited trap is installed, involving removal of stones on top of the artificial refuge traps (ARTs), checking for presence of crayfish and finally installing the baited trap between the ARTs.

Once this has been carried out for each individual ART, the baited traps were put into position (Fig 3.4). This procedure was carried out at each site resulting in all appropriate ARTs being checked; crayfish presence recorded and baited traps set in the unique standardised location for each site.

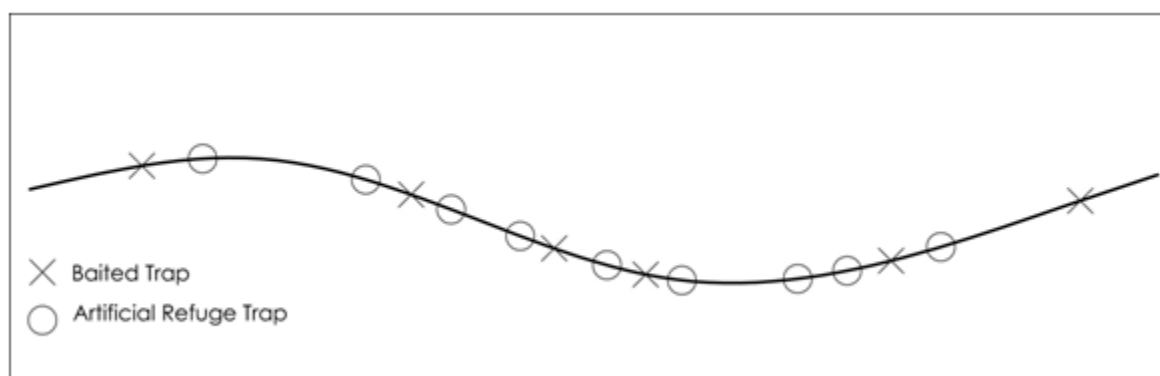

Figure 6. The experimental design for positioning artificial refuge trap (ARTs) and baited traps at Site 1.

The researchers left the baited traps in place for 24 hours and returned the next day with a qualified team who removed any crayfish caught in both the ARTs and baited traps.

### 3.2 Crayfish Translocation Procedure

The researcher along with members of the Environment Agency (EA), Nicky Green and Devon Wildlife Trust carried out the crayfish translocation. Each member of the team was equipped with waders and a flexible plastic bucket, which had string around the handles that enabled the buckets to be carried over the shoulder for ease in the river. Several callipers were divided between the team which were used to measure the size of each crayfish caught. One member of the team was allocated to record the results whilst the other members went to every trap at each site and emptied them.

On approach of an ART, the team member placed river water in the bucket to a couple of inches depth. The bucket was balanced by the researcher as they carried out the same procedure that was used in the site preparation to remove the ART. The contents of the trap were tipped into the bucket, capturing any crayfish that were present. The trap was carefully rinsed to remove excess silt and debris and continued to be emptied in the bucket until the trap was visibly clear. The tag number of the trap was noted and the presence of crayfish was reported to the member of team who was recording.

If any crayfish were present in the bucket, they were taken to the river bank where they were examined to determine the species by feeling for the barbs located behind the eyes upon the carapace. The gender was identified and the length of the carapace was measured using the callipers and recorded along with the number of trap it was from (*Plate 15*). The crayfish were placed into a cool-box containing river water and leaves in preparation for the translocation to an ark site.

The baited traps were second to be checked, in order to minimise the risk of losing any crayfish that could have been present in the ART, through disturbance. The individual baited trap was approached by a team member who lifted the trap out of

the water and thoroughly looked inside to decipher whether any crayfish were present. The trap was removed from the bank and if any crayfish were present, the trap was carried towards the area where crayfish were measured. Both ends of the trap were able to be twisted off and so the end nearest the crayfish was removed. The crayfish were carefully removed from the trap and the same data analysis as used from the ARTs was carried out on gender, size and species. The data was recorded and the crayfish were placed inside the cool-box. The bait was removed from the bait box and once it was emptied it was replaced inside the trap. The baited traps were placed at the entrance to the study site to be collected and removed from the site once the survey was completed.



*Plate 15.* The buckets were used to empty the artificial refuge traps (ARTs) and transport the crayfish to the side of the river where the length of the carapace was measured using callipers and the size of crayfish was recorded along with which trap it came from.

### **3.3 Habitat Survey**

The habitat survey was specifically aimed at characteristics that crayfish prefer. The researcher recorded detail on river depth (m), river features, a list of refuges in the channel and riverbank, the main substrate type, level of siltation and percentage of shade cover. The depth was estimated and the river features were identified using numbers; 1 represented marginal deadwater, 2 a pool, 3 a glide, 4 a run and 5 was a riffle.

The refuge options for channel and riverbank consisted of a list of different sized cobbles, boulders, rubble, woody debris, tree roots and other types. All appropriate refuges were ticked with the most dominant type of refuge circled. The siltation level was due to the researcher's opinion on whether it was low, moderate or high. These factors were analysed and recorded at each cluster of ARTs along the river bank at each site.

### **3.4 Data Analysis**

Statistical analysis was carried out using Minitab 16 statistical software. Box and whisker plots were used to compare the median size of crayfish, different substrate compositions and main habitat refuge types. The boxplot shows the top 25% of data in the distance between the top whisker and the box, the middle 50% of the data set is represented within the box with the middle line defining the median and the bottom 25% is shown in the distance between the bottom whisker to below the box. Any outliers in the data sets are displayed as an asterisk. The non-parametric Kruskal-Wallis test was used to test whether there were significant differences between the medians of the data used in the boxplots, with the  $p$  value being displayed on the boxplot. Scatter graphs were created using Microsoft Excel 2010 software and the correlation coefficient was calculated through Excel.

## **4.0 Results**

### **4.1 Comparison of Artificial Refuge Traps (ARTs) and Baited Traps**

In total, 66 crayfish were caught in the four study sites, of these, 43 were caught in ARTs and 23 in baited traps. A Mann Whitney U test was carried out to test the significance between using ARTs or baited traps. The total catch of crayfish for ARTs at all four study sites was tested against the total for baited traps. The  $p$  value was 0.9967, which demonstrates that there is not a significant difference between the capture rates of each type of trap. Each individual site was tested for the difference between using each trap, all of which returned as insignificant, supporting the theory that it does not statistically matter which type of trap was used as the capture difference was not large enough.

Each study site was compared against the other three sites for the total number of males caught in ARTs at each site. This was repeated for the comparison of each site for the capture of males in baited traps. The same process was carried out for the capture of female crayfish in each type of trap at each site. The Mann Whitney U analysis derived no significant  $p$  values for any of the sites, suggesting that none of the sites were significantly better at capturing males or females in either ARTs or baited traps.

Statistical analysis was carried out, testing the difference between males caught in ARTs against males caught in baited traps at each site. Female crayfish capture rates were also tested in this manner. The results for both males and females had no significant  $p$  values, showing that there is no significant difference between the capture rates of ARTs and baited traps in the capture of each gender of crayfish.

Furthermore, the data gathered on the presence of crayfish in ARTs before baited traps were installed, was tested against the number present after baited traps were located next to the ARTs for 24 hours. The statistical analysis derived a  $p$  value of 0.9491 showing that there was no significant difference between the number observed without baited traps and the number present when the baited traps were in place. This suggests that the presence of bait (fresh sardines) was not a limiting factor when determining whether crayfish would be present in the ARTs. The total number of crayfish observed before instalment of baited traps and the total number

caught was compared for each site to demonstrate the variability of crayfish remaining in the ARTs (Fig 7).

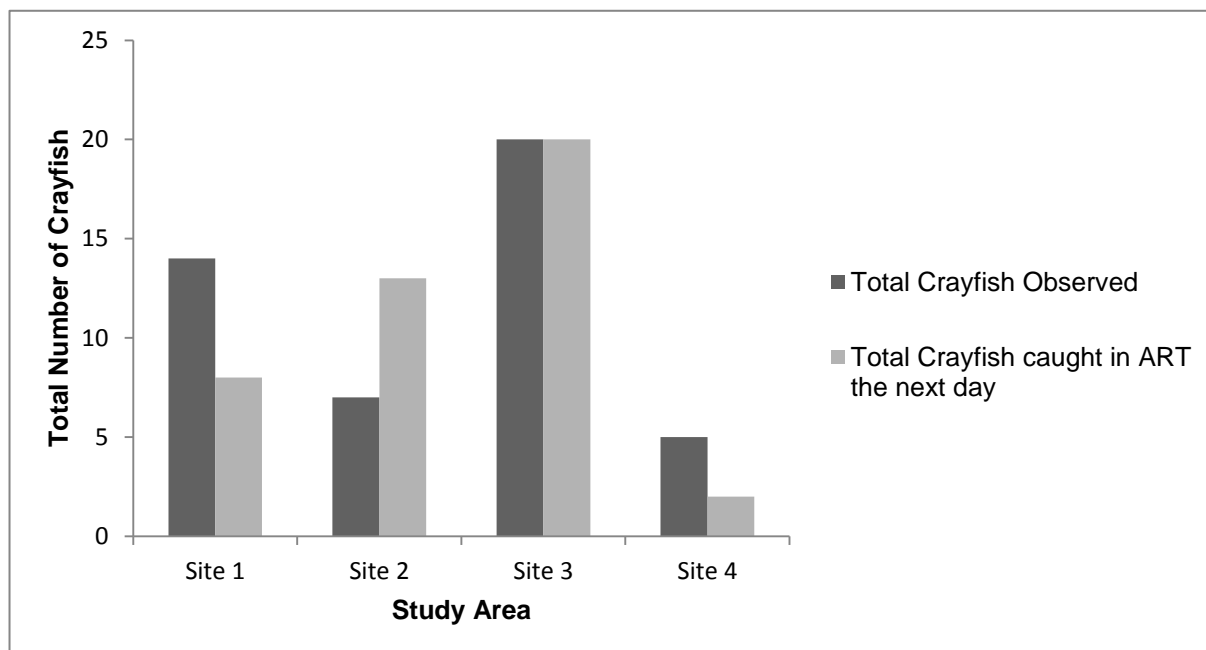

Figure 7. The total count of *Austroptamobius pallipes* observed in artificial refuge traps (ARTs) before the instalment of baited traps, compared to the count of crayfish found in ARTs after the baited traps have been in place for 24 hours.

Site 1 and Site 4 shows that there were more crayfish in the ARTs when checked before a translocation day. This suggests that the process of removing the traps to check could have led to crayfish leaving the refuge when it was replaced. Site 2 suggests a higher mobility rate of the crayfish present due to more crayfish being present the day after.

#### 4.2 Size of Crayfish

The average size of males and females were calculated for ARTs and baited traps; the results for males were 30.36 mm and 43.25 mm whilst the females were 31.88 mm and 45.11 mm respectively. This demonstrates that larger crayfish of both sex occurred in baited traps. The size range of males and females in both types of trap were also analysed (Table 3).

Table 3. The size range (mm) of male and female *Austroptamobius pallipes* caught in both artificial refuge traps (ARTs) and baited traps at each study site.

| Study Area | ART Male (mm) | Baited Trap Male (mm) | ART Female (mm) | Baited Trap Female (mm) |
|------------|---------------|-----------------------|-----------------|-------------------------|
| Site 1     | 22.1 – 31.2   | 34.4 – 55.1           | 18.5 – 26.4     | 44.8 – 47.1             |
| Site 2     | 17.7 – 50.0   | 39.9 – 46.4           | 23.9 – 44.2     | 41.8 – 48.9             |
| Site 3     | 18.1 – 48.8   | 28.1 – 50.4           | 26.6 – 43.9     | 0                       |
| Site 4     | 29.9          | 39.8                  | 35.9            | 37.7 – 51.0             |

The baited traps contained a narrower size range but it tended to be higher than the diverse range of sizes caught in ARTs. At site 3, no females were caught in the baited traps whereas a broad size of females were caught using the ARTs. This suggests that ARTs are more successful at capturing a broader age structure which is arguably more beneficial when translocating a population to provide diversity.

The relationship for the size of male and female crayfish caught in ARTs was compared over time (Fig 8). The relationship between size and time of trapping was weak for both males and females with the correlation coefficient analysis producing  $R^2$  values of 0.3606 and 0.4504 respectively. For both females and males there was a chain of three consecutive decreases throughout the trapping period.

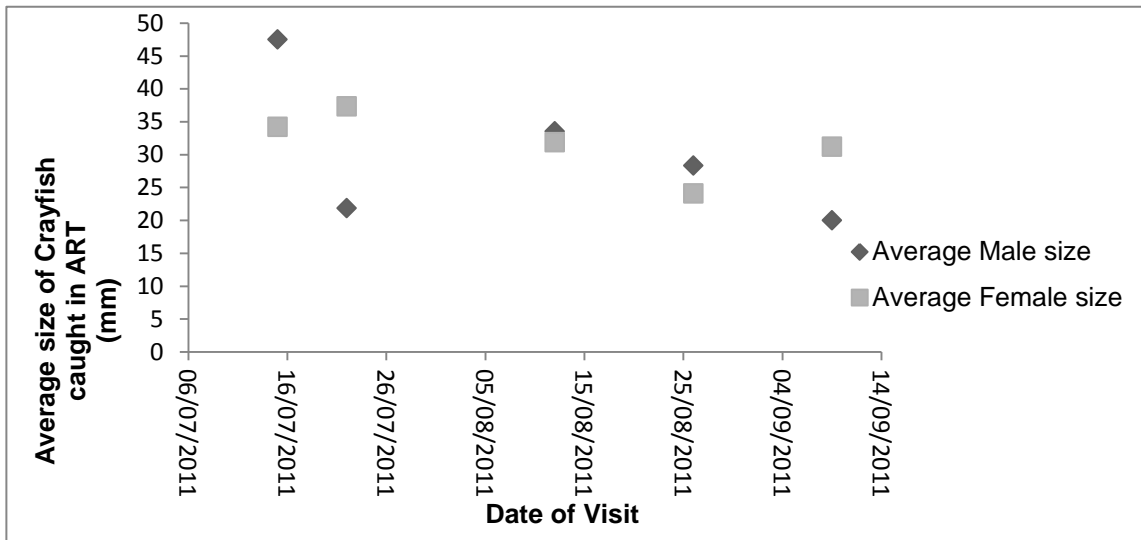

Figure 8. A comparison of the average size of male and female crayfish caught in artificial refuge traps (ARTs) over the study period.

The results for baited traps concurs that in the middle three trapping sessions, the average female size was larger (Fig 9). This suggests a healthy adult female proportion of the crayfish population were actively foraging. However, no females were caught in baited traps in the first trapping session on the 15<sup>th</sup> July 2011.

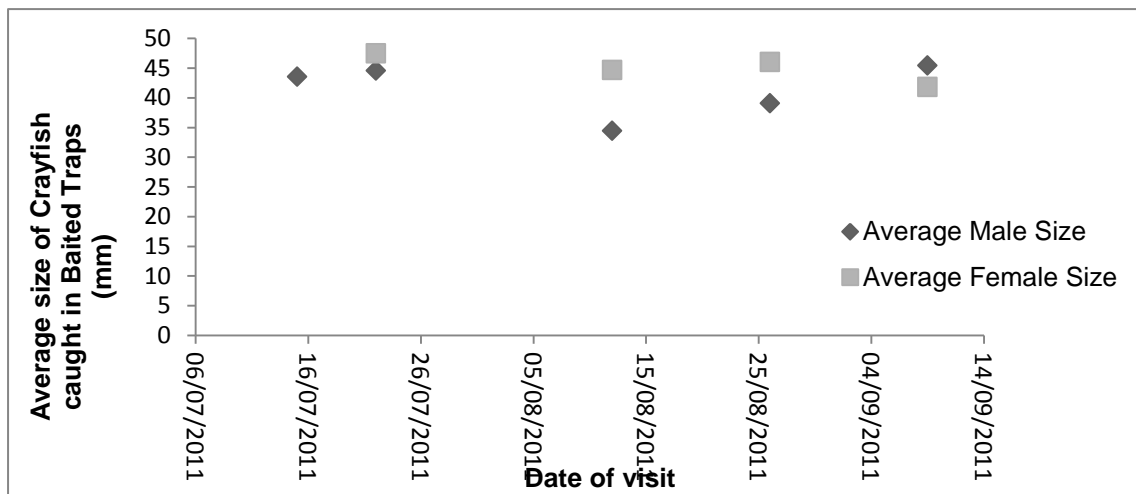

Figure 9. A comparison of the average size of male and female crayfish caught in Baited Traps over the study period.



In comparison to the ARTs, the relationship between the sizes of crayfish caught in baited traps over time was weaker, particularly in males ( $R^2$  value of 0.0112). This suggests that the length of time does not impact the size of crayfish caught in the baited traps.

The median size of males and females caught in both types of trap have been summarised (Fig 10). The medians for males and females caught in ARTs are very close with a difference of 2.3 mm, although there is a much larger and more evenly spread of size for females. It is important to note the outliers shown in males caught in ARTs, showing that those four males are significantly bigger than the rest of the sample, which have a much lower median. This suggests that it was possible to catch large adult males using ARTs rather than the baited traps.

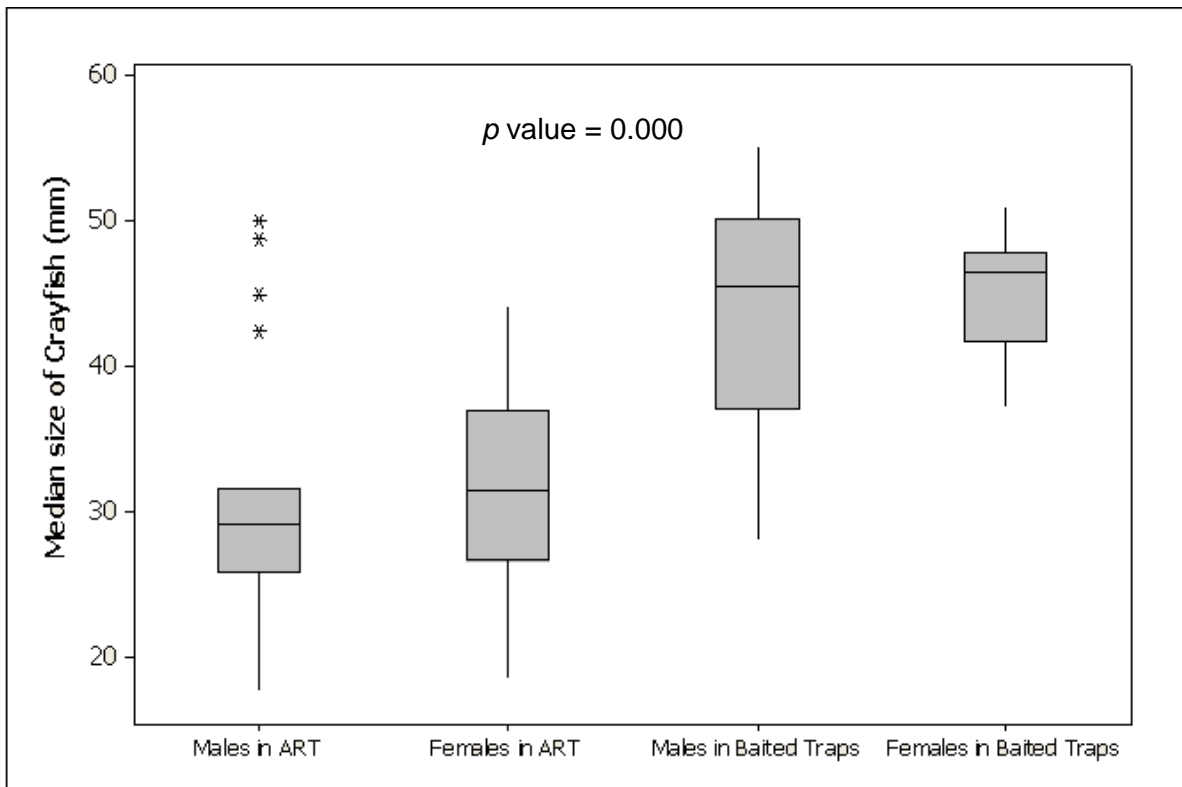

Figure 10. The median size of male and female crayfish caught in artificial refuge traps (ARTs) and baited traps. The size of crayfish was measured using callipers from the snout to the end of the carapace.

The median size for males and females caught in baited traps are visibly larger compared to the results for ARTs. There is also a smaller difference of 1.1 mm between the median size of males and females caught in baited traps. There is a much larger inter-quartile range for the males in contrast to the more concise results for the females. A Kruskal-Wallis analysis test was used to analyse the difference in medians shown in Figure 10. This resulted in a  $p$  value of 0.000, thus there is a significant difference between the lowest median (males in ARTs) and the highest median (females in baited traps).

The ratio of males and females located at each site was calculated (Table 4). Site 1 had similar ratios for males and females for both types of trap. The biggest difference for the female crayfish was in Site 3, where none were caught in baited traps

throughout the whole study period. In contrast, 42.11% of the total ART catch in site 3 were female, suggesting that the females were more prone to seeking refuge rather than being drawn to the fresh sardines in the baited traps.

**Table 4.** The percentage of the total count of male and female crayfish caught in artificial refuge traps (ARTs) and baited traps at each study site.

| Study Area | ARTs     |            | Baited Traps |            |
|------------|----------|------------|--------------|------------|
|            | Male (%) | Female (%) | Male (%)     | Female (%) |
| Site 1     | 62.50    | 37.50      | 60.00        | 40.00      |
| Site 2     | 38.46    | 61.54      | 44.44        | 55.56      |
| Site 3     | 57.89    | 42.11      | 100.00       | 0.00       |
| Site 4     | 50.00    | 50.00      | 11.11        | 88.89      |

Furthermore, there is a contrast in the capture ratio of each type of trap at site 4; ARTs had an even record of obtaining both males and females, whereas the baited trap were more weighted at catching females with an 88.89% success rate. This suggests that there is a high number of hunting females located in this area.

### 4.3 Count of Male and Female Crayfish over time

The number of males and females caught were mapped over the study time period to investigate the success of ARTs and baited traps in capturing the population over time. The correlation coefficient was calculated for the males and females caught in ARTs (Fig 11 and 12). The correlation analysis produced  $R^2$  value for males and females as 0.1244 and 0.0167 respectively, which suggests there was a very weak correlation between the length of trapping time and the reduction in the number of crayfish caught.

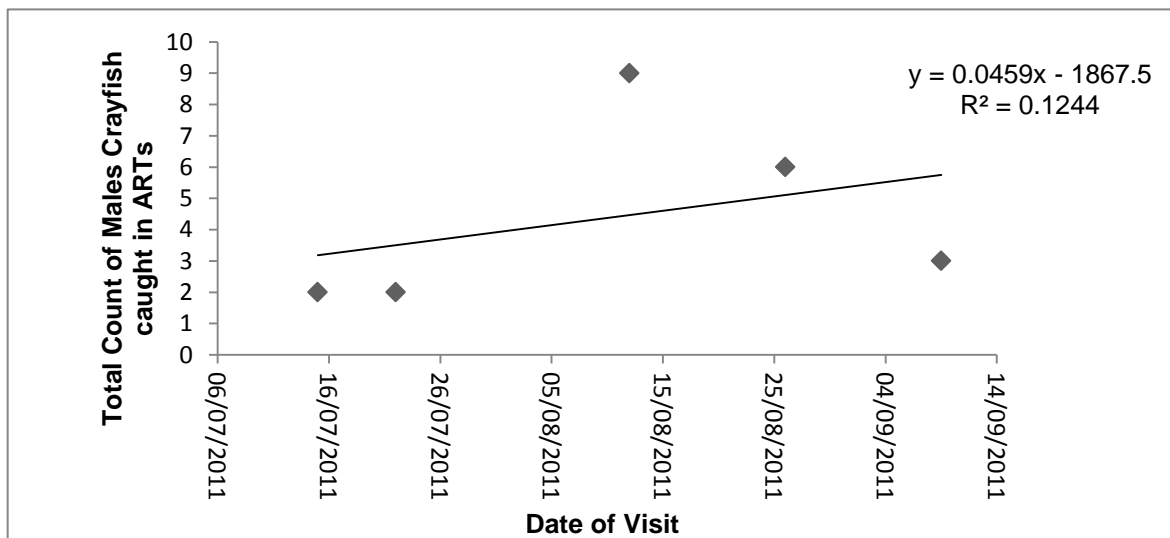

Figure 11. The relationship between the length of the study period and the total number of male crayfish caught in artificial refuge traps (ARTs).

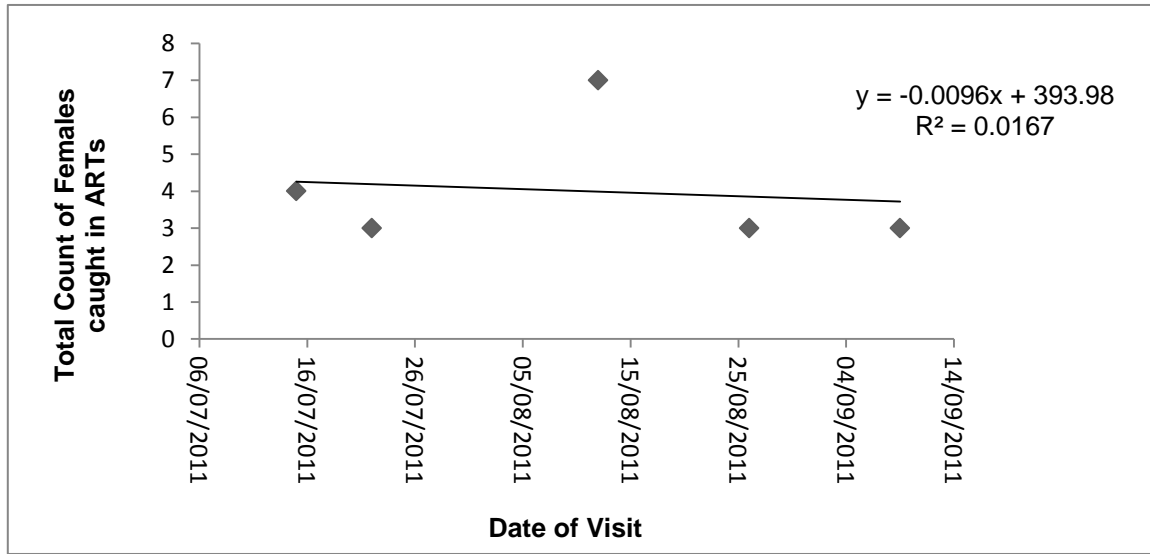

Figure 12. The relationship between the length of the study period and the total number of female crayfish caught in artificial refuge traps (ARTs).

The correlation between the capture of males in baited traps over time has the highest positive correlation although it is not strong, as the  $R^2$  value is 0.402 (Fig 13). This suggests that from August to September the number of males being caught began to rise, implying that there the study period was not sufficient in capturing all of the male crayfish. In comparison to the success of ARTs in capturing males, the baited trap has a stronger correlation, suggesting that this method is more ideal for catching larger numbers of males as time goes on.

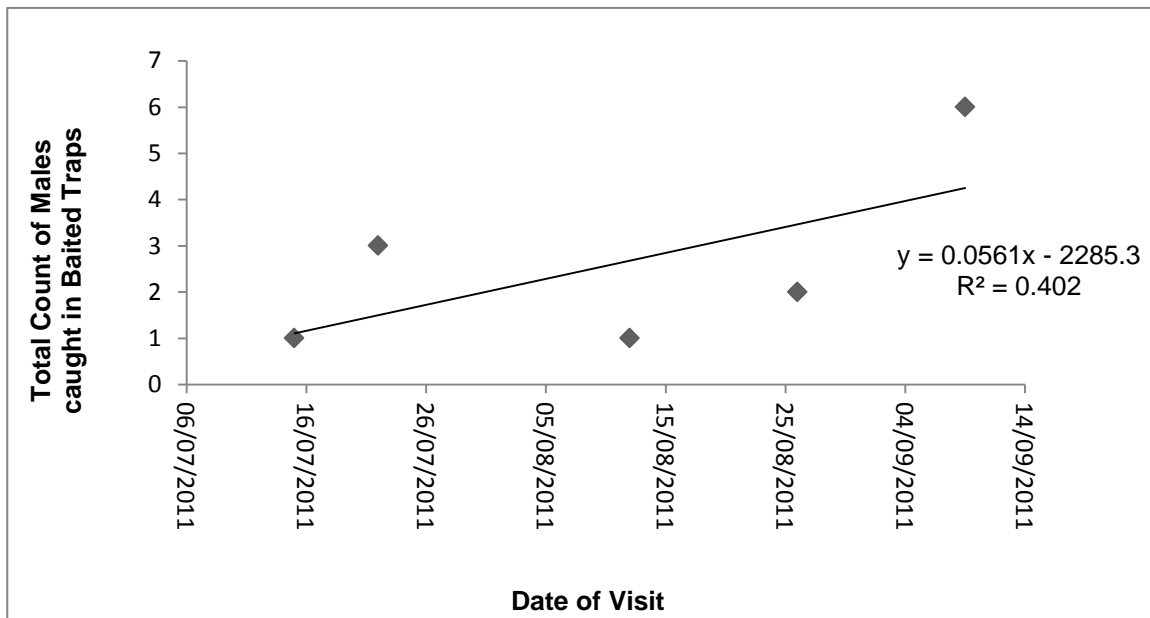

Figure 13. The relationship between the length of the study period and the total number of male crayfish caught in baited traps.

In contrast there is no correlation between the numbers of female crayfish caught over time in the baited traps as the correlation analysis produced a  $R^2$  value of 0 (Fig

14). The result for female crayfish in ARTs is also low suggesting no link between type of trap and female preference.

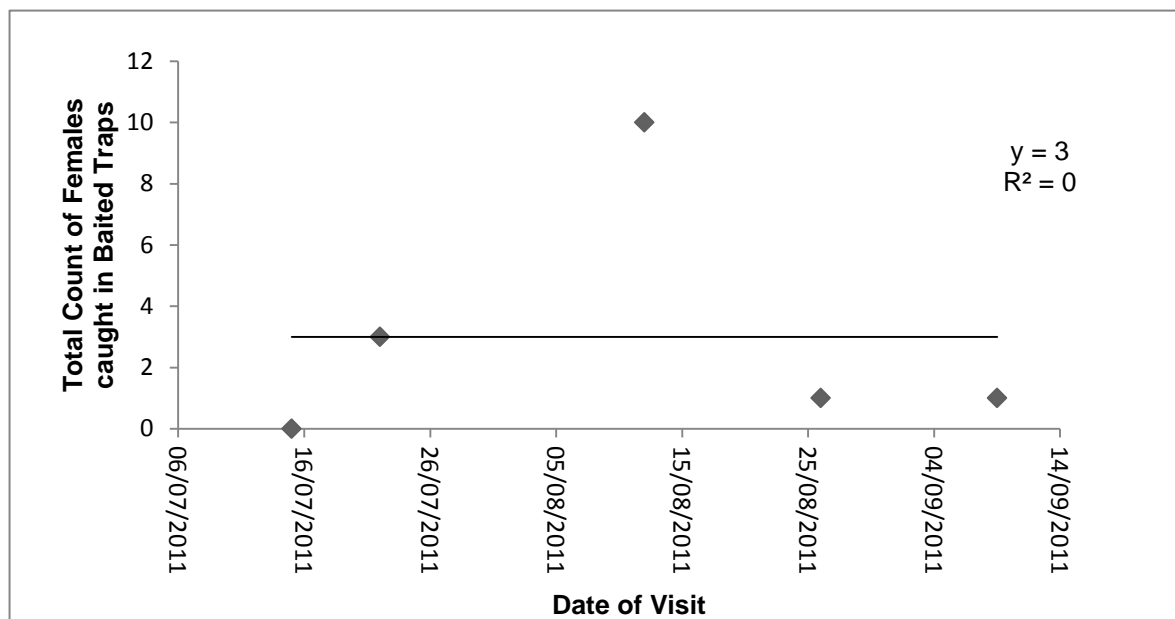

Figure 14. The relationship between the length of the study period and the total number of female crayfish caught in baited traps.

The aim for successful translocation of the whole crayfish population is to continue trapping until there is a negative correlation which would suggest that the majority of the population had been caught.

#### 4.4 Habitat Preference of Crayfish

A habitat survey was undertaken which was aimed specifically at environmental characteristics that provide ideal crayfish habitat. This was carried out at each cluster of ARTs on the river bank. These clusters have been labelled alphabetically at each site and were determined by grouping ARTs that were next to each other in the same area on the river bank. The clusters vary from a single trap, to a maximum of three depending on how dispersed the ARTs were at each site. To account for the varying number in each group, the average number of crayfish caught per trap was calculated. The number of crayfish caught in each ART has been linked to the results of the habitat surrounding the traps at each site (Table 5).

**Table 5.** The results of the crayfish habitat survey carried out at each artificial refuge trap (ART) cluster, linked with the capture rate of each ART group at Site 1. Pebbles and Cobbles are classified as < 6.5 cm and 6.5 – 15cm respectively.

| ART group | Number of ARTs in group | Depth of water (m) | Main refuges in river bank   | Main substrate beneath | Siltation | Shading (%) | Average number of crayfish caught per trap |
|-----------|-------------------------|--------------------|------------------------------|------------------------|-----------|-------------|--------------------------------------------|
| A         | 3                       | 0.3                | Tree Roots covering mud bank | Pebbles                | High      | 100         | 2                                          |
| B         | 2                       | 0.2                | Tree Roots covering mud bank | Cobbles                | Moderate  | 100         | 0                                          |
| C         | 3                       | 0.2                | Tree Roots covering mud bank | Cobbles                | Moderate  | 100         | 0.33                                       |
| D         | 1                       | 0.3                | Tree Roots covering mud bank | Pebbles                | Low       | 100         | 1                                          |

All of the ARTs are positioned at different points along the right river bank at Site 1. The results demonstrate that the majority of crayfish were caught in the three traps in group A, which contains dominantly tree roots covering the mud river bank with pebbles making up the substrate. High siltation and shading do not appear to be a controlling factor on the presence of crayfish. Furthermore, the two ART groups; B and C have the same habitat composition, yet the later group obtained one crayfish whereas the other caught none, which highlights the lack of relationship with these variables.

Site 2 has a more varied capture percentage than Site 1 (Table 6). The dominant river bank refuge of trees covering mud appears to be the most successful at attracting crayfish to that area. There appears to be no relationship between the type of substrate and the average number of crayfish caught per trap.

**Table 6.** The results of the crayfish habitat survey carried out at each artificial refuge trap (ART) cluster linked with the capture rate of each ART group at Site 2. Gravel is classified as < 1.6 cm.

| ART groups | Number of ARTs in group | Depth of water (m) | Main refuges in river bank   | Main substrate beneath | Siltation | Shading (%) | Average Number of crayfish caught |
|------------|-------------------------|--------------------|------------------------------|------------------------|-----------|-------------|-----------------------------------|
| A          | 1                       | 0.3                | Tree Roots covering mud bank | Pebbles                | Moderate  | 80          | 0                                 |
| B          | 2                       | 0.4                | Tree Roots covering mud bank | Pebbles                | Moderate  | 90          | 1.5                               |
| C          | 2                       | 0.3                | Tree Roots covering mud bank | Gravel                 | Moderate  | 100         | 2                                 |
| D          | 1                       | 0.1                | Tree Roots covering mud bank | Pebbles                | Moderate  | 100         | 2                                 |
| E          | 2                       | 0.3                | Tree Roots covering mud bank | Gravel                 | Moderate  | 100         | 0.5                               |
| F          | 1                       | 0.2                | Dry Stone Wall               | Gravel                 | Moderate  | 80          | 0                                 |
| G          | 1                       | 0.4                | Dry Stone Wall               | Gravel                 | High      | 50          | 1                                 |
| H          | 1                       | 0.3                | Cobbles/Boulders             | Gravel                 | Moderate  | 100         | 0                                 |

Furthermore, the percentage cover of shade does not appear to have a direct impact on the presence of crayfish due to the inconsistency of capture rate as in groups A and F which are both 80%, none were caught, whereas one was caught in group G which has 50% shade coverage. Additionally the depth of water in the marginal areas of the river does not appear to affect the presence of crayfish as the three ART groups that caught the most crayfish consists of depths of 0.1m, 0.3m and 0.4m, suggesting that there is no relationship.

Site 3 was the only site where at least one ART in each cluster caught a crayfish (Table 7). The most common type of refuge was the river bank covered in tree roots and with cobbles underneath. However, there is still no suggestion of a relationship between as group D also has these conditions and has caught only one crayfish.

**Table 7.** The results of the crayfish habitat survey carried out at each artificial refuge trap (ART) cluster linked with the capture rate of each ART group at Site 3.

| ART groups | Number of ARTs in each group | Depth of water (m) | Main refuges in river bank   | Main substrate beneath | Siltation | Shading (%) | Average number of crayfish caught per trap |
|------------|------------------------------|--------------------|------------------------------|------------------------|-----------|-------------|--------------------------------------------|
| A          | 2                            | 0.4                | Tree Roots covering mud bank | Pebbles                | Moderate  | 100         | 0.5                                        |
| B          | 1                            | 0.3                | Tree Roots covering mud bank | Cobbles                | Low       | 100         | 1                                          |
| C          | 1                            | 0.3                | Tree Roots covering mud bank | Gravel                 | Low       | 100         | 3                                          |
| D          | 1                            | 0.2                | Tree Roots covering mud bank | Cobbles                | Moderate  | 100         | 1                                          |
| E          | 2                            | 0.1                | Tree Roots covering mud bank | Cobbles                | Moderate  | 100         | 3.5                                        |
| F          | 2                            | 0.1                | Cobbles                      | Cobbles                | Low       | 80          | 2.5                                        |
| G          | 2                            | 0.3                | Cobbles                      | Pebbles                | Moderate  | 100         | 0.5                                        |
| H          | 2                            | 0.4                | Cobbles                      | Pebbles                | Moderate  | 100         | 0.5                                        |

Groups E and F, which caught the highest average number of crayfish per trap, both had depths of 0.1m and a high presence of cobbles. This suggests that at this site the crayfish prefer shallow water with cobbles present to provide shelter. The water characteristics at these two clusters were classified as marginal dead water, meaning that the water was shallow and calm, making it easier for the crayfish to access refuges. Siltation does not seem to impact the presence of crayfish as they have been recorded in both moderate and low levels of siltation.

The final site has a low record of catching crayfish in ARTs (Table 8). It is important to note the presence of a weir at the upstream limit of the study site, as well as the dry stone blockwork providing ample refuge for the crayfish, potentially limiting the need to use the ARTs.

**Table 8.** The results of the crayfish habitat survey carried out at each artificial refuge trap (ART) cluster linked with the capture rate of each ART group at Site 4.

| ART groups | Number of ARTs in each group | Depth of water (m) | Main refuge in bank          | Main substrate beneath | Siltation | Shading (%) | Average number of crayfish caught per trap |
|------------|------------------------------|--------------------|------------------------------|------------------------|-----------|-------------|--------------------------------------------|
| A          | 1                            | 0.3                | Cobbles                      | Cobbles                | Low       | 100         | 0                                          |
| B          | 1                            | 0.3                | Tree Roots covering mud bank | Cobbles                | Low       | 100         | 1                                          |
| C          | 2                            | 0.3                | Dry Stone Wall               | Gravel                 | Low       | 100         | 0.5                                        |
| D          | 1                            | 0.3                | Tree Roots covering mud bank | Cobbles                | Low       | 100         | 0                                          |
| E          | 1                            | 0.2                | Tree Roots covering mud bank | Cobbles                | Low       | 90          | 0                                          |
| F          | 1                            | 0.4                | Dry Stone Wall               | Cobbles                | Moderate  | 90          | 0                                          |

The characteristics at group B, which caught one crayfish, were repeated in group D although the latter did not obtain any crayfish, suggesting no relationship between these factors. However, the location along the river may have been more of an influence as group B was located 30m downstream of the weir whereas group D was located 10m downstream of the weir. Therefore the river features consisting of glides and runs could have had more of an impact on the ARTs nearest the weir.

The other crayfish was caught in group C located 15m downstream of the weir, suggesting that the fast flow of water near the weir and the inability of crayfish to climb this obstacle potentially results in the crayfish congregating further downstream.

Statistical analysis of relationship between the average number of crayfish caught per trap against the main substrate and the main bank refuge was investigated (*Fig 15 and 16* respectively). Kruskal-Wallis tests were carried out to determine whether the main types of substrate samples had the same median. The result gave a  $p$  value of 0.657, showing that there was not a significant difference between the medians of each sample.



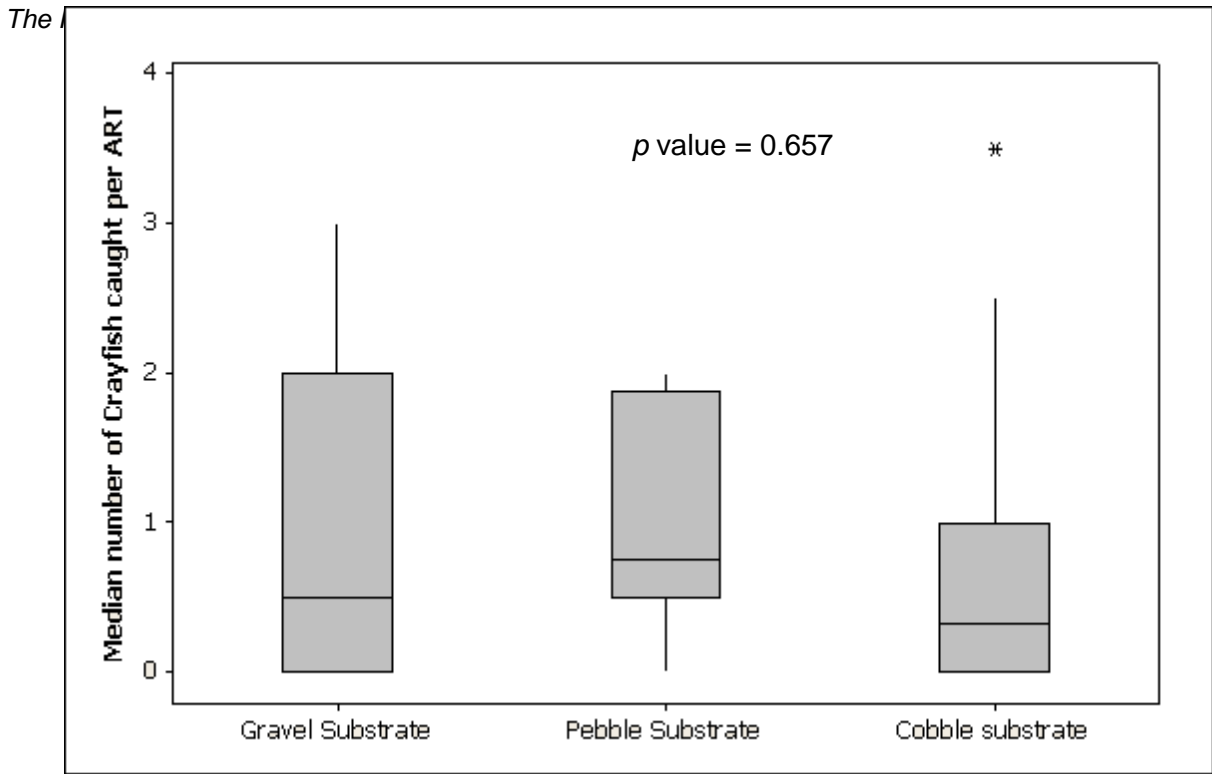

Figure 15. The main types of substrate beneath the artificial refuge traps (ARTs) identified during the habitat survey. Pebbles and cobbles are defined as < 6.5 cm and between 6.5 cm – 15 cm respectively.

Pebbles had the highest median value of an average of 0.75 crayfish caught per trap, with the lowest being present in cobble substrate. However, although the general distribution of crayfish was low in cobbled substrate, there was an outlier for 3.5 crayfish being caught per trap. The statistical analysis and distribution of data in Figure 15 show that there is no relationship between substrate and presence of crayfish at any of the study sites.

The same analysis was undertaken for the main refuge type in the river bank (Fig 16). The survey determined that the main refuge type was tree roots covering the mud riverbank and so it was compared against an amalgamation of the remaining habitat types (dry stone wall, cobbles and boulders) under stone embankment. The Kruskal-Wallis statistical analysis derived a  $p$  value of 0.144, showing that there is not a significant difference between the median number of crayfish caught in either type of refuge on the river bank.

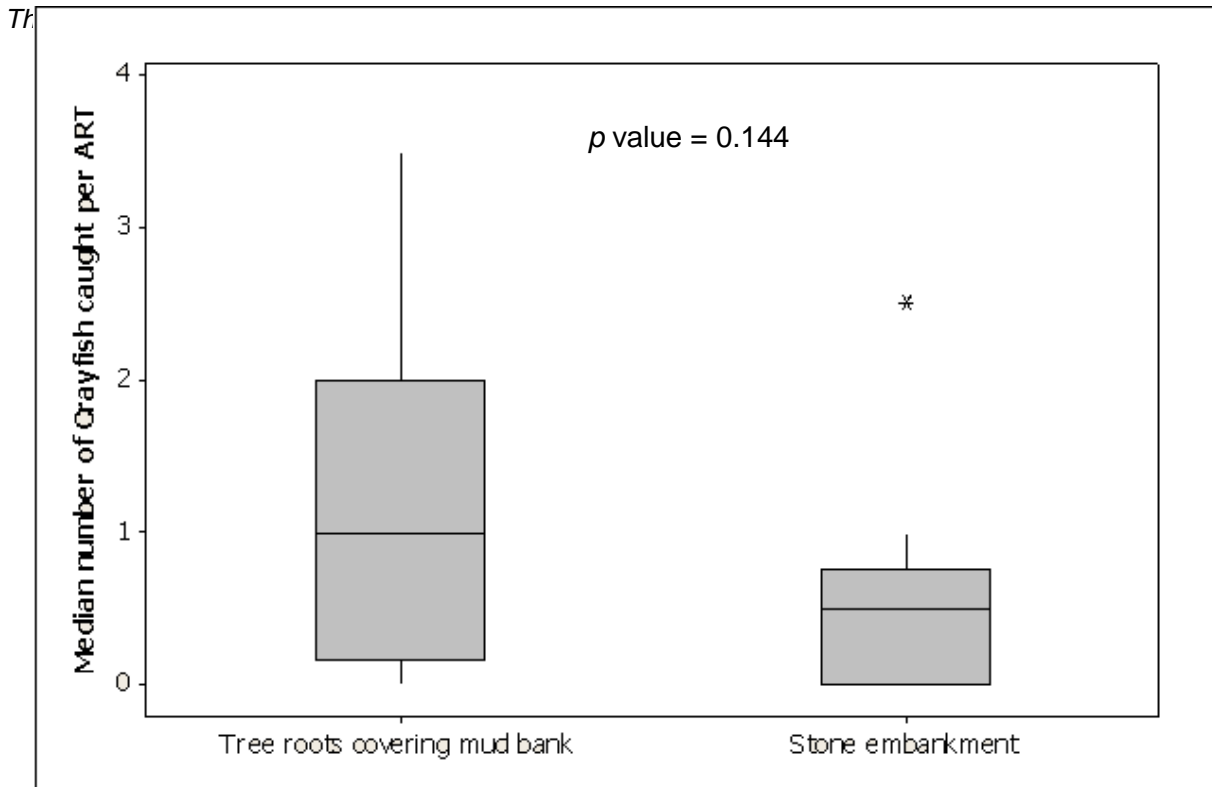

Figure 16. A comparison of the median number of crayfish caught in artificial refuge traps (ARTs) in the main refuge types in the river bank. Tree roots covering mud bank was the main type so has been compared against stone embankment which is an amalgamation of dry stone wall, cobbles and boulders refuge types.

Tree roots covering the mud bank has the highest median of an average of one crayfish caught per trap, with a total of 17 data sets. In contrast, the median value for stone embankment consists of an average of 0.5 crayfish per trap in those conditions; also there were 9 data sets which were much lower than the tree root condition. The right river bank has a strip of woodland on the bank above so naturally there was a higher presence of tree roots in the bank. However, there was an outlier of the stone embankment condition had caught an average of 2.5 crayfish per trap, which suggest individual crayfish could prefer this habitat.

Correlations were calculated to investigate the strength of relationship between the environmental variables including river depth (m), percentage of shade cover and level of siltation against the average number of crayfish per trap. The river depth was estimated at each cluster of ARTs (Fig 17). The correlation analysis derived a  $R^2$  value of 0.1292 which suggests that there was almost no relationship between depth of the river and presence of crayfish. It may be important to note that the range in river depth was only 0.3 m.

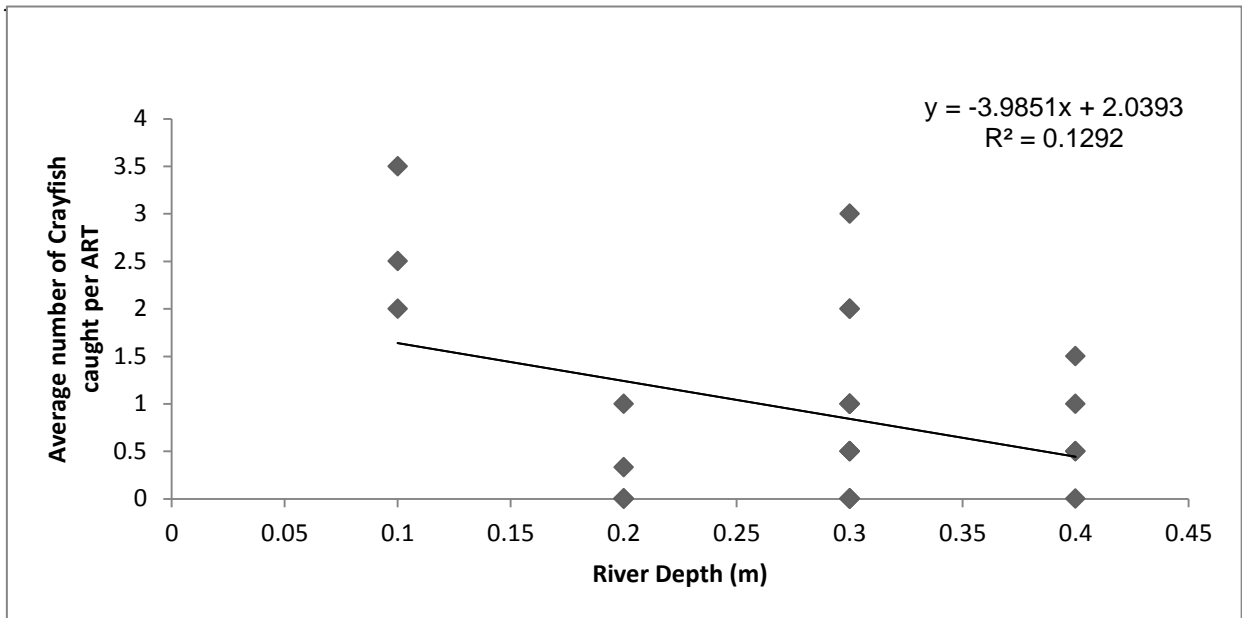

Figure 17. The relationship between river depth (m) and the average number of crayfish caught in each individual artificial refuge trap (ART).

The influence of shade cover on the average number of crayfish caught per trap was analysed (Fig 18). The  $R^2$  value of 0.0031 demonstrates an even weaker relationship than river depth had. Most of the sites had a 100% shade cover due to the presence of a woodland strip on the right river bank and trees being present on the left bank as well.

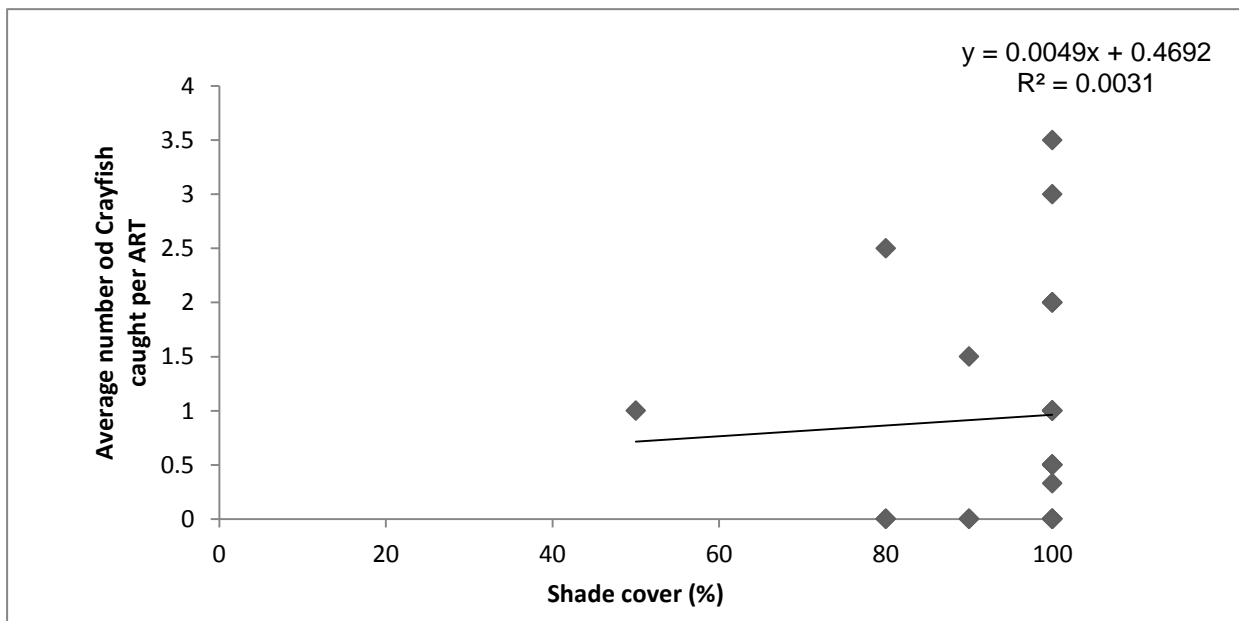

Figure 18. The relationship between percentage of shade cover and average number of crayfish caught in each individual artificial refuge trap (ART).

The siltation level was interpreted during the habitat survey as low, moderate to high. The correlation analysis derived a  $R^2$  value of 0.0013 which depicts a very weak relationship between the levels of siltation and the number of crayfish present.

## 5.0 Discussion

The aim of this thesis was to identify whether artificial refuge traps (ARTs) or baited traps had the highest capture rate on the *A. pallipes* population in the Creedy Yeo River, Devon. To achieve this aim, many factors have been analysed and tested. This chapter endeavours to explain the findings of these results and link them with past research to develop a clearer understanding of the best method to trap the *A. pallipes* population.

### 5.1 Capture Rate

When analysing the data from either ARTs or baited traps, only the capture rate can be measured, rather than the capture efficiency. There is no set value for an efficient capture rate for *A. pallipes* in these traps, thus the data cannot be compared to test the level of efficiency. The capture rate is measured through the average number of crayfish caught in each individual trap.

The capture rate can be used by fishing industries to measure abundance of a population whether it is for crabs, lobsters or crayfish (Miller, 1990). However, this is not a well established correlation due to the variety of factors that influence the capture rate. These include the temperature, stage of moult and reproductive cycles along with the sex and size of the species (Miller, 1990). This can be applied to the effects of the traps on the Creedy Yeo River where the baited traps were not consistent in the average number of crayfish caught per trap. The fresh sardine used as bait draws the crayfish to the trap but it also limits the catch as well due to the unpredictability of how hungry the crayfish are, which is reliant on the availability of natural food sources.

### 5.2 Comparison of Crayfish caught in Artificial Refuge Traps (ARTs) and Baited Traps

Although, in total, the ARTs caught more crayfish, it is important to note that there were 46 ARTs distributed unevenly throughout the four study sites, whereas there were only 24 in total for traps (6 at each site). Therefore this was not a fair representation of the baited traps as there were relatively low numbers present at each site creating a bias towards ARTs.

The results for the baited traps showed that larger male and female crayfish were caught in comparison to the ARTs, although the ARTs contained a wider size range. The wider range could benefit trapping for translocation purpose as it covers a larger proportion of the population. Larger crayfish being caught in baited traps concurs with current knowledge on the subject such as research on the Sherston Avon and Tetbury Avon, Wiltshire, where baited traps were also used to catch *A. pallipes* (Spink *et al.*, 2000). These baited traps caught larger crayfish in comparison to stone turning and suggested that the two different methods were attracting different age classes (Spink *et al.*, 2000). This assumption could be applied to the size of crayfish caught from ARTs and baited traps, implying that the ARTs were better at catching younger crayfish. The juvenile crayfish are expected to have left the female from June (Holdich, 2003), as trapping began on the 14<sup>th</sup> July, a larger proportion of the overall *A. pallipes* population could be juveniles, depending on the success of breeding. Further research has suggested that the difference in crayfish size for each type of trap could be linked to habitat preference of juveniles and adults as the juveniles prefer shallow marginal areas (Blake *et al.*, 1993).

Additionally, the adults could be quicker at finding the bait as the type of bait is the main attraction to baited traps rather than refuge, so active adults are attracted to this style of trap, which skews the ability to capture across the age range of a population (Peay, 2003). The adults could deter the juveniles from entering the trap as adult crayfish can eat juveniles.

### **5.3 Influence of Population Density and Trapping Issues**

The Creedy Yeo River hosts a low density, discontinuous population which impacts the reliance of the capture rates of baited traps or ARTs. The results suggest that the population was not depleted by the end of the study period (approximately 2 months). Additionally, the size of crayfish remained high throughout the study period, suggesting that there was a relatively high adult population. This could also be linked to higher movement nearer the breeding season.

Baited traps have been noted in research to be unreliable in low densities, implying that over 20 traps are required if the population is not at high enough density (Brown *et al.*, 1978). This estimate could potentially explain the unreliable capture rate obtained at the study sites as there were only 6 baited traps in place at each site; a relatively low number. An example of how effective baited traps can be in high densities was demonstrated in a river in Wiltshire, where approximately 320 *A. pallipes* were caught each day using 56 baited traps (Green, *pers. comm.*, 2012).

In order to gain a less biased result, it would have been more beneficial to have used a larger number of baited traps to fully test the level of capture in small populations. Furthermore, the surveys were carried out in the summer months where crayfish range over a wider area (Ibbotson *et al.*, 1995). Individuals in the population could expand from the study area during these high activity months to areas with a potentially higher food source or more refuges, thus reducing the appeal of either the ARTs or baited traps.

One of the most difficult components of a translocation is ensuring that a wide enough range of the population has been accounted for, in order to successfully breed. This is a common issue when trapping is carried out for any protected species as it is important to trap as many of the population as possible in order to minimise risk of killing or injuring the species which could be illegal. There is not a set length of time to trap for *A. pallipes* which is an issue as it creates a higher risk of not removing the majority of the population. If there was a guideline then it could result in more crayfish being translocated.

### **5.4 Crayfish Behaviour**

Site 1 and Site 4 had a higher presence of crayfish observed the day before a translocation, when the ARTs were checked before the baited traps were installed. Research was carried out on the ranging behaviour of *A. pallipes*, where radio-tracking was used to monitor movements (Robinson *et al.*, 2000). This study suggested that crayfish that were trapped and then released demonstrated the largest movements during the two days after capture, suggesting a fright response to being captured (Robinson *et al.*, 2000). This could be linked to the process of removing the trap, lifting it vertically and using a torch to observe whether any crayfish were present could have resulted in the 'fright' response, causing the crayfish to leave the trap once it was placed back in the river. This could have

particularly impacted Site 4 due to the presence of dry-stone walling and a weir, resulting in an abundant availability of other refuges thus reducing the need to use the ARTs.

However, this process is not consistent throughout all of the sites as Site 2 had higher total numbers caught on the translocation day. This could be linked to higher site fidelity which is reported to be common in other decapods crustaceans (Vanninni *et al.*, 1995). This is further supported by other research which suggests that, after a fright response, crayfish make large movements and then remain in a confined area for several days before moving on to a new area for several days (Robinson *et al.*, 2000). This implies that certain crayfish in a population may demonstrate higher site fidelity, which could be applied to the crayfish population located at Site 2, as numbers were higher on the translocation day. Additionally, the presence of bait could have had a stronger impact on keeping the crayfish in this area.

*A. pallipes* have demonstrated a level of territorial behaviour potentially leading to the largest, most territorial crayfish, being attracted to the baited traps thus influencing the bias towards larger crayfish (Holdich *et al.*, 1995). The larger, more dominant crayfish could reach the baited trap first, preventing juvenile crayfish entering the trap due to risk of predation.

Research noted that the highest level of activity occurred after dusk, with night-time localised activity occurring and then the crayfish would return to the same refuge (Gherardi *et al.*, 1998). The night-time activity was assumed to be foraging behaviour. If this behaviour is linked to the results of the Creedy Yeo River populations then, if there was a naturally high level of food source in the river, then the crayfish would not be attracted to the baited traps and has the potential to return to the ARTs.

It is important to look into the ecological characteristics required by *A. pallipes* to fully understand the best methods to protect and conserve the species (Sutherland, 1996). It would also benefit the translocation process by identifying key areas which are most likely to catch the highest abundance of crayfish. Furthermore, it would aid in finding the most appropriate ark sites with features that would aid the highest success probability of the population.

### **5.5 Habitat Evaluation**

Rivers are dynamic systems resulting in a varied distribution of invertebrates depending on environmental conditions (Robinson *et al.*, 2000). The habitat characteristics have been researched with an aim to link certain variables with the presence of crayfish. Analysis of the data demonstrated there was not a significant relationship between percentage of shade cover and the average number of crayfish caught in Artificial Refuge Traps (ARTs). However, previous research has identified the presence of trees as strongly influential on the presence of crayfish due to canopy cover and overhanging boughs (Naura *et al.*, 1998). This suggests that shade is very important for the presence of crayfish. Due to the natural characteristics of the riverbanks at each site; most of the ARTs were placed in areas ranging from 80% to 100% shade cover. The main proportion of crayfish were caught in these high shade areas, supporting previous literature but the survey

quantity limits the ability of the findings being significant due to small areas in the study sites providing less shade.

Research produced a suggested link between trees providing an important food source for organisms in the river channel (Naura *et al.*, 1998). This was supported by Reynolds (1979) who recorded presence of crayfish with leaf litter adding to the food availability. The presence of trees is high along the Creedy Yeo River, due to the strip of woodland present on the right bank of the river with the left bank also supports trees that line the field boundary of the agricultural land. This could potentially be linked with the relatively low catch of crayfish in baited traps, as overhanging trees provide sources of food such as invertebrates which may fall from overhanging leaves into the river (Mason *et al.*, 1982). As crayfish are omnivores, they would make the most of this source, potentially hindering the influence of the fresh sardines which were used as bait to lure the crayfish into the traps. This variable is among many influential factors that may have resulted in a low catch.

Further positive features of a habitat for crayfish presence were recorded as a high presence of exposed boulders and boulder/cobbles banks providing a mixture of refuge sizes (Naura *et al.*, 1998). The protection of cobbles is dependent on the size, Foster (1993) stated that there was a significant relationship between the area of cobble and the carapace length of the crayfish beneath. This research suggested that this strong link was caused by the minimum area needed to protect the crayfish from predation and light (Foster, 1993). Therefore a mixture of boulders and cobbles would provide a variety of refuges for different age groups. Furthermore, refuges are available to juveniles through underwater tree roots (Rogers *et al.*, 1995). The dominant refuge type in the river bank at the study sites consisted of tree roots covering a mud bank followed by stone embankments. If this is linked to the previous research, then this is an ideal habitat to support juveniles which could explain the smaller median size of males and females caught in ARTs. The tree root environment caught more crayfish, which may be bias as this was the main refuge type along the Creedy Yeo River. Although research has suggested that many stone embankments, including gravel, pebble and sand banks, can be associated negatively with *A. pallipes* (Naura *et al.*, 1998), there were still some crayfish caught in gravel substrates.

It has been recognised that crayfish would use dry-stone walls as a source of refuge as they are able to exploit the gaps between the stones (Naura *et al.*, 1998). This could explain the low capture rate from Site 4 as there was a weir located at the upstream point of the study area with dry-stone wall present in stages along the right bank, providing ample ideal refuges. At this site, the baited traps had the highest capture rate of 9 crayfish over the entire study period. It is important to note that this was not evenly spread over time; in one trapping session 7 adult female crayfish were caught in one baited trap which fits with the assumption that the presence of large adults deters juveniles as none were present. The ARTs had a much lower catch of 2 crayfish at this site. The design of the ARTs is tailored towards mimicking a refuge thus the impact of this is hindered in a site which naturally provides a wide variety of refuges. However, it can increase the influence of baited traps, which can draw crayfish out of their refuges to eat. This suggests that the environmental variables can influence the type of trap and the efficiency of the capture rate.

Further environmental variables considered included the level of siltation and the depth of river water (m) present around the traps. Research has suggested that high concentrations of suspended solids have a detrimental impact on the abundance of crayfish (Natura *et al.*, 1998). The impacts are caused through indirectly reducing the amount of habitats available to crayfish. This factor did not appear to cause a significant difference in the average number of crayfish caught in ARTs. The majority of crayfish were caught in moderate levels of siltation as the river banks had no protection from erosion. Additionally the depth of the river did not impact the average number of crayfish, although there was a very low range of depths throughout the sites. This finding is supported by research on the distribution of *A. pallipes* in France as there was no significant relationship between crayfish presence and water depth along a brook (Broquet *et al.*, 2002). A fair assumption would be that if there had been a larger difference between water depth then there would be higher potential for a relationship to occur. The population that was studied in France was described as heterogeneous which can also be applied to the populations along the Creedy Yeo River. Additionally, further research claims that crayfish density is closely linked to habitat characteristics at different scales (Neveu, 2000).

### **5.6 Limitations to Trapping Methodology**

The main constraint in the methodology used in this study was the lack of control over the number of ARTs at each site. Trapping was already taking place at these four sites, with a primary aim to catch crayfish for translocation, when this thesis began. The uneven numbers of ARTs at each site could lead to a bias in catching crayfish in these traps, rather than the baited traps. It also makes assumptions invalid as it is not a fair comparison to test the two different types of traps against each other. To improve on this in future work, when comparing the two types of traps, there should be even numbers of ARTs and baited traps at each site.

Additionally, the number of baited traps available for the four study sites was limited due to the number available from the Environment Agency at the time of research, along with transportation limitations to and from the sites. If the population is known to be of low density, then more than 6 traps should be used, if possible, to identify whether a higher bait presence would draw more crayfish to the traps.

The choice of bait impacts the success of baited traps, as different types of bait could have a stronger influence on the number of crayfish drawn to these traps. This thesis is based on fresh sardines used as bait due to the availability at the beginning of research. If time constraint was not an issue, it would be beneficial to research which bait was most effective for attracting *A. pallipes*.

### **6.0 Conclusion**

To achieve optimal results in capturing a dispersed, low density *A. pallipes* population, it is crucial to understand any relationship between this species and its surrounding habitat. This allows for traps to be placed in the most ideal location whether it is dependent on the level of shade, siltation or type of refuge available. This, along with a broader understanding on which trapping method is most suitable to individual sites, can aid the conservation of Britain's only native crayfish species. The main aim conservation is to capture a broad age range to support a breeding population in a safe alternative site whilst efforts to control the spread of non-indigenous species are continued.



The main findings of this research concur that the artificial refuge traps (ARTs) caught more crayfish over a broader size range, in comparison to baited traps which attracted larger males and females along the Creedy Yeo River, Devon. This suggests that if the younger proportion of the population is targeted for translocation, then it is more ideal to use the ARTs. There did not appear to be a preference in the gender of crayfish and the type of trap used, which is to gain a wide range of the population. There was no significant difference in the number of crayfish caught the day after baited traps were put in place, suggesting that bait did not attract a significantly higher presence of crayfish to the area. This suggests that it is more effective and time efficient to use one method of trapping, rather than combining the ARTs and baited traps as they appeared to have little impact on each other.

These findings can be taken into consideration when considering translocation work on other rivers containing low density populations. The Creedy Yeo River demonstrated that small populations can exist dispersed in habitats which provide ample refuges, although further research is required.

### **6.1 Further Research**

Further analysis of the size of all of the crayfish that have been relocated would give a better understanding of the age range that has already been translocated. This could be used to analyse whether more adults or juveniles are required to support a breeding population. This analysis would determine which trap would be of most beneficial use as the baited traps attract larger adults and the ARTs is more tailored towards juveniles, although can catch larger adults.

This study did not truly identify the full use of baited traps and so further study using a larger number of baited traps at each site along the Creedy Yeo River would give a better impression of the success of this method.

Additionally, expanding research methods into controlling the spread of American Signal Crayfish could provide more time to translocate the native crayfish by slowing the movement. This would allow survey methods to be more effective if time is not a strong constraint.

## References

Blake. M, Hart. P. (1993) Habitat preferences and survival of juvenile signal crayfish, *Pacifastacus leniusculus*- the influence of water depth, substratum, predatory fish and gravid female crayfish. *Freshwater Crayfish*, pp. 318-332.

Broquet. T, Thibault. M, Neveu. A. (2002). Distribution and habitat requirements of the white-clawed crayfish, *Austropotamobius pallipes*, in a stream from the Pays de Loire region, France: An experimental and descriptive study. *Bull. Fr. Peche Piscic.* 367, pp 717-728.

Brown. D, Brewis. J. (1978). A critical look at trapping as a method of sampling a population of *Austropotamobius pallipes* (Lereboullet) in a mark and recapture study. *Freshwater Crayfish* 4, pp 159-164.

Crayfish Project Performa. (2010). Creedy Yeo white-clawed and signal mixed population monitoring. Environment Agency, pp 1 – 2.

Devon BAP. (2009). White-clawed Crayfish. Devon Biodiversity and Geodiversity Action Plan. *Devon Biodiversity Partnership*, pp 1-9

Devon Wildlife Trust. (2004). Creedy-Yeo catchment. Crayfish Survey Report. *Devon Wildlife Trust*, pp 1-15.

EA. (2011) Crayfish trap guidelines. [online]. Available at: <http://www.environment-agency.gov.uk/homeandleisure/recreation/fishing/38051.aspx> (Accessed on 13/01/2012).

Ellis. A. (2009). *Non-native invasive crayfish within the Thames Basin, Environment Agency internal report*, Thames Region, London, pp 51.

Foster. J. (1993). The relationship between refuge size and body size in the crayfish *Austropotamobius pallipes*, *Freshwater Crayfish*, 9, pp 345–349.

Green. N. (2009). Guidance on the use of Artificial Refuge Traps for White-clawed and non-native crayfish species. Green Ecology Ltd, pp 1-4.

Green. N. (2012). Personal communication via email.

Gherardi. F, Barbaresi. S, Villanelli. F. (1998). Movement patterns of the white-clawed crayfish, *Austropotamobius pallipes*, in a Tuscan stream. *Freshwater Ecology*, 134, pp 413-424.

HGBI. (no date). Evaluating local Mitigation/Translocation Programmes: Maintaining Best Practice and lawful standards. *Herpetofauna Groups of Britain and Ireland advisory notes for Amphibian and reptile groups*, pp 1-8

Holdich D (2003). Ecology of the White-clawed Crayfish. *Conserving Natura 2000 Rivers Ecology Series No. 1*. English Nature, Peterborough.

Holdich. D, Rogers. W, Reader. J. (1995) Crayfish Conservation. *R&D Project 379*, National Rivers Authority. Bristol.

Holdich. D, Reynolds. J, Souty-Grosset. C, Sibley. P. (2009). A review of increasing threats to European Crayfish. *Knowledge and Management of Aquatic Ecosystems*. 11, pp 394-395.

Ibbotson. A, Furse. M, Dewey. K. (1995). The distribution and baseline survey of the crayfish populations in the River Thames. Institute of Fresh Water Ecology, pp 1 -9.

JNCC. (2011). The Convention on the Conservation of European Wildlife and Natural Habitats. Joint Nature Conservation Committee. [online]. Available at: <http://jncc.defra.gov.uk/page-1364> (Accessed on 14/12/2011).

Lowery. R. (1988). Growth, moulting and reproduction. *Freshwater crayfish: biology, management and exploitation*. Croom Helm, London, 83–113.

Mason. J, MacDonald. S. (1982). The input of terrestrial invertebrates from tree canopies to a stream, *Freshwater Biology*, 12, pp 305–331.

Miller. R. (1990). Effectiveness of crab and lobster traps. *Canadian Journal of Fisheries and Aquatic Sciences*. 47(6), pp 1228 – 1251.

Naura. M, Robinson. M. (1998). Principles of using River Habitat Survey to predict the distribution of aquatic species: an example applied to the native white-clawed crayfish *Austropotamobius pallipes*. *Aquatic Conservation: Marine and Freshwater Ecosystems*. 8, pp 515-527.

Neveu. A. (2000). Distribution according to habitat structure: stability and variability over five years. *Bull. Fishing. Piscic. Fr.*, 356, pp 99-122.

National Rivers Authority. (1995). Crayfish Conservation. *National Rivers Authority*. Bristol.

Ordnance Survey. (2012). Map of Crediton, Devon. [online]. Available at: <http://www.getamap.ordnancesurveyleisure.co.uk/> (Accessed on 12/01/2012).

Peay S (2000). Guidance on works affecting white-clawed crayfish. *English Nature and Environment Agency report*. English Nature, Peterborough.

Peay. S. (2003). Monitoring the White-clawed crayfish. *Conserving Natura 2000 Rivers Ecology*. Series 1. English Nature, Peterborough.

Peay. S. (2006). Conserving White-clawed crayfish in England and Wales. Briefing notes for Wildlife Trusts.

Peay. S. (2009). Selection criteria for “ark sites” for white-clawed crayfish. Crayfish Conservation in the British Isles, *Proceedings of conference held in Leeds*, pp 63–69.

Robinson. C, Thom. T, Lucas. M. (2000). Ranging behaviour of a large freshwater invertebrate, the white-clawed crayfish *Austropotamobius pallipes*. *Freshwater Biology*. 44 (3), pp 509-521.

Rogers. W, Holdich, D. (1995). *Survey of white-clawed crayfish distribution in the tributaries of the Rivers Usk and Wye*, Contract Science Report 137, Countryside Council for Wales, Bangor.

Reynolds, J. (1979). Ecology of *Austropotamobius pallipes* in Ireland, *Freshwater Crayfish*, 4, pp 215–219.

Scott. A. (2000). Crayfish conservation: legislating for non-native species. *Proceedings of the Crayfish Conference in Leeds*, pp 27-32.

South-West Crayfish Conservation Strategy. (2008). [online]. Available at: <http://www.buglife.org.uk/conservation/currentprojects/Species+Action/UK+Crayfish+Website/Crayfish+for+professionals/Crayfish+research+and+projects/SW+England> (Accessed on 27/01/2012).

Spink. J. Frayling. M. (2000). An assessment of post plague re-introduced native white-clawed crayfish, *Austropotamobius pallipes*, on the Sherston Avon and Tetbury Avon, Wiltshire. *Proceedings of the Crayfish Conference in Leeds*. Pp 36 – 44.

Sutherland. W. (1996) *From Individual Behaviour to Population Ecology*. Oxford University Press, Oxford.

Taylor. C. (2002). Taxonomy and conservation of native crayfish stocks. *Biology of Freshwater Crayfish*, Blackwell Science, Oxford, pp 236–257.

WildaboutBritain. (2006). American Signal Crayfish photograph. [online]. Available at: <http://www.wildaboutbritain.co.uk/pictures/showphoto.php/photo/13665> (Accessed on 12/12/2011).

Varia. S. (2010). Could invasive species signal the end for native crayfish? [online]. Available at: <http://cabiinvasives.wordpress.com/2010/11/11/could-invasive-species-signal-the-end-for-the-white-clawed-crayfish/> (Accessed on 13/12/2011).

Vanninni. M, Cannicci. S. (1995). Homing behaviour and possible cognitive maps in crustacean decapods. *Journal of Experimental Marine Biology and Ecology*, 193, pp 67 – 91.